

MCH/MGH Single and Dual DC-DC Converters

28 VOLT INPUT – 1.5 WATT

FEATURES

Small footprint, 0.79 in² (5.1 cm²) - MCH

Surface mount package - MGH

- Operating temperature -55°C to +125°C
- Input voltage 12 to 50 VDC
- Transient protection 80 V for up to 120 ms
 - 70 V for 15 V single and dual models
- Fully isolated, magnetic feedback
- Fixed frequency switching
- Inhibit function
- Short circuit protection
- Undervoltage lockout
- Up to 79% efficiency



MODELS	
VDC OUTPUT	
SINGLE	DUAL
5	±5
12	±12
15	±15

DESCRIPTION

The Interpoint™ MCH Series™ and MGH Series™ of dc-dc converters deliver 1.5 watts of output power while saving significant board real estate. The wide input voltage range of 12 to 50 VDC accepts the varying voltages of military, aerospace, or space bus power and tightly regulates output voltages to protect downstream components. Transient protection of 80 volts for up to 120 milliseconds exceeds the requirements of MIL-STD-704A for the 5 and 12 volt single models and the 12 volt dual model. The 15 volt single and dual converters will withstand transients of up to 70 volts for up to 120 milliseconds.

The converters are offered with standard screening, “ES” screening, or fully compliant to “883” MIL-PRF-38534 Class H screening. See “Table 11: Element Evaluation” on page 12 and “Table 12: Environmental Screening” on page 13. Standard microcircuit drawings (SMD) are available. See “Table 5: MCH SMD Numbers” on page 4 and “Table 6: MGH SMD Numbers” on page 4.

CONVERTER DESIGN

MCH Series and MGH Series of dc-dc converters incorporate a continuous flyback topology with a constant switching frequency of approximately 370 kHz. Current-mode pulse width modulation (PWM) provides output voltage regulation. Output error voltage is magnetically fed back to the input side of the PWM to regulate output voltage. Regulation is also affected by the load; refer to the Electrical Characteristics Table 9 on page 6 and Table 10 on page 7.

Dual models regulate the negative output with magnetic coupling to the positive output. Up to 80% of the total load may be on one output providing that the other output carries a minimum of 20% of the total load. The dual models can be used at double the output voltage by connecting the load between positive and negative outputs, leaving the common unconnected. (ex: MCH2805D can be used as a 10 VDC output.)

INHIBIT FUNCTION

MCH and MGH converters provide an inhibit terminal that can be used to disable internal switching, resulting in no output voltage and an input current as low as 2.3 mA. The converter is inhibited when the inhibit pin is pulled below 0.8 V and enabled when its inhibit pin is left floating. An external inhibit interface should be capable of pulling the converter’s inhibit pin below 0.8 V while sinking the maximum inhibit current and also allowing the inhibit pin to float high to enable the converter. A voltage should not be applied to the inhibit pin. The open circuit voltage present on the inhibit pin is 7 to 12 V.

PROTECTION FEATURES

Undervoltage lockout prevents the converters from operating below approximately 8 VDC input voltage to keep system current levels smooth, especially during initialization or re-start operations. All models include a soft-start function to prevent large current draw and minimize overshoot. The converters also provide short circuit protection by restricting the current.

MIL-STD-461

Use the Interpoint FMSA-461 (down-leaded) or FMGA-461 (surface mount, side-leaded) EMI filters to pass the CE03 requirements of MIL-STD-461C.

MCH/MGH Single and Dual DC-DC Converters

28 VOLT INPUT – 1.5 WATT

PACKAGING

MCH - Down-leaded package

The MCH Series converters are packaged in hermetically sealed, projection-welded metal cases which provide EMI/RFI shielding. See "Figure 21: MCH Case Dimensions" on page 10.

MGH - Surface mount package

The surface mount MGH dc-dc converters can be mounted with pick-and-place equipment or manually. It is recommended that the case be attached with flexible epoxy adhesive or silicone which is thermally conductive (>1 watt /meter/ $^{\circ}$ K).

Internal components are soldered with SN96 (melting temperature 221° C) to prevent damage during reflow. Maximum reflow temperature for surface mounting the MGH converter is 220° C for a maximum of 30 seconds. SN60, 62, or 63 are the recommended types of solder. Hand soldering should not exceed 300° C for 10 seconds per pin.

The hermetically sealed metal cases are available in two different lead configurations. See "Figure 22: MGH Case Dimensions" on page 11 and "Figure 23: MGH Gull-Wing Solder Pad Layout" on page 11.

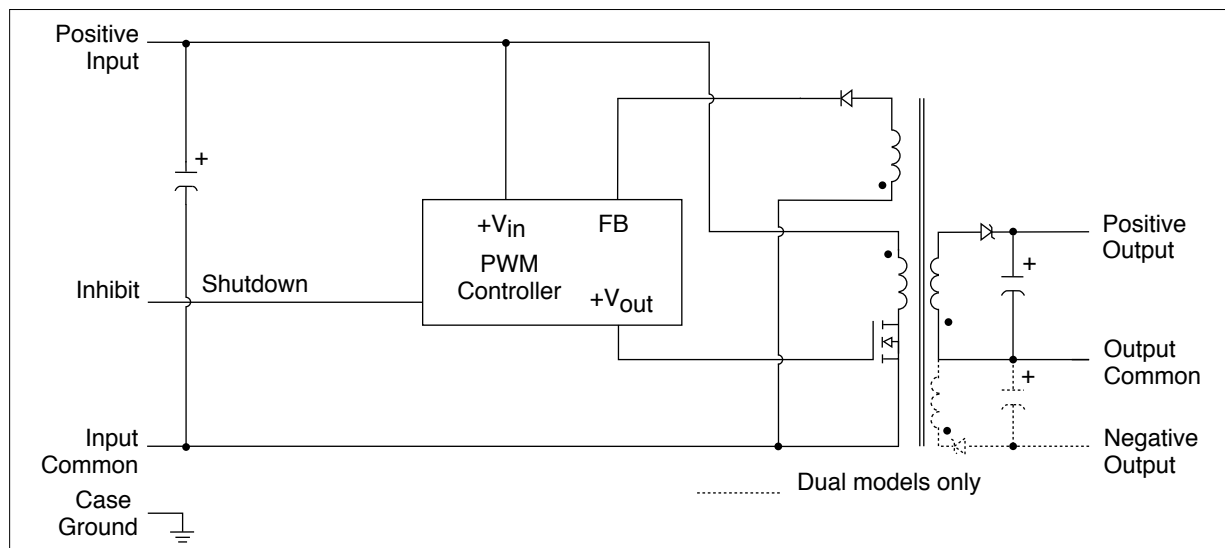

FIGURE 1: MCH/MGH BLOCK DIAGRAM

MCH/MGH Single and Dual DC-DC Converters

28 VOLT INPUT – 1.5 WATT

PIN OUT MCH MODELS		
Pin	Single Output	Dual Output
1	Positive Input	Positive Input
2	Input Common	Input Common
3	Positive Output	Positive Output
4	Output Common	Output Common
5	Case Ground	Case Ground
6	No Connection	Negative Output
7	Inhibit	Inhibit

TABLE 1: MCH PIN OUT

PIN OUT MGH MODELS		
Pin	Single Output	Dual Output
1	Positive Input	Positive Input
2	No Connection	No Connection
3	Input Common	Input Common
4, 5	Positive Output	Positive Output
6, 7	Case Ground	Case Ground
8, 9	Output Common	Output Common
10, 11	Case Ground	Case Ground
12	No Connection	No Connection
13, 14	No Connection	Negative Output
15, 16, 17	No Connection	No Connection
18	Inhibit	Inhibit

To meet specified performance for the MGH, all pins must be connected except "No connection" pins and Inhibit pin.

TABLE 2: MGH PIN OUT

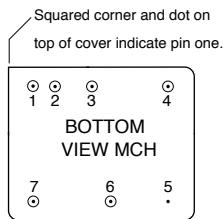

See case A2 for dimensions.

FIGURE 2: MCH PIN OUT

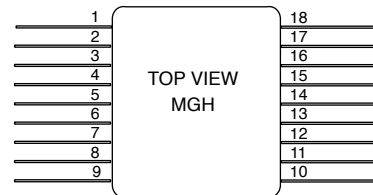

Differently colored glass bead around pin one or dimple in header (bottom or side of case) indicates pin one. Cover marking is oriented with pin one at the upper right corner.

See case B for dimensions and "gull-wing" option.

FIGURE 3: MGH PIN OUT

MCH PINS NOT IN USE	
Inhibit	Leave unconnected
"No Connection" pin	Leave unconnected

TABLE 3: MCH PINS NOT IN USE

MGH PINS NOT IN USE	
Inhibit	Leave unconnected
"No Connection" pins	Connect to case ground for best EMI performance. Also ok to leave unconnected.

TABLE 4: MGH PINS NOT IN USE

MCH/MGH Single and Dual DC-DC Converters

28 VOLT INPUT – 1.5 WATT

SMD NUMBERS	
STANDARD MICROCIRCUIT DRAWING (SMD)	MCH SIMILAR PART
5962-9569601HXC	MCH2805S/883
5962-9569701HXC	MCH2812S/883
5962-9569801HXC	MCH2815S/883
5962-9570201HXC	MCH2805D/883
5962-9570301HXC	MCH2812D/883
5962-9570401HXC	MCH2815D/883

For exact specifications for an SMD product, refer to the SMD drawing. SMDs can be downloaded from: <http://www.dsccl.dla.mil/programs/smcr>

TABLE 5: MCH SMD NUMBERS

SMD NUMBERS	
STANDARD MICROCIRCUIT DRAWING (SMD)	MGH SIMILAR PART
5962-9569601HZC	MGH2805SZ/883
5962-9569701HZC	MGH2812SZ/883
5962-9569801HZC	MGH2815SZ/883
5962-9570201HZC	MGH2805DZ/883
5962-9570301HZC	MGH2812DZ/883
5962-9570401HZC	MGH2815DZ/883

For exact specifications for an SMD product, refer to the SMD drawing. SMD numbers are shown for the surface mount gull-wing case. For the straight-lead case, replace the Z (HZC) in the SMD with a Y (HYC). SMDs can be downloaded from: <http://www.dsccl.dla.mil/programs/smcr>

TABLE 6: MGH SMD NUMBERS

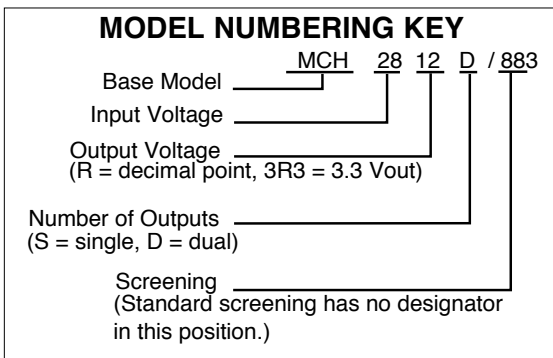

FIGURE 4: MCH MODEL NUMBERING KEY

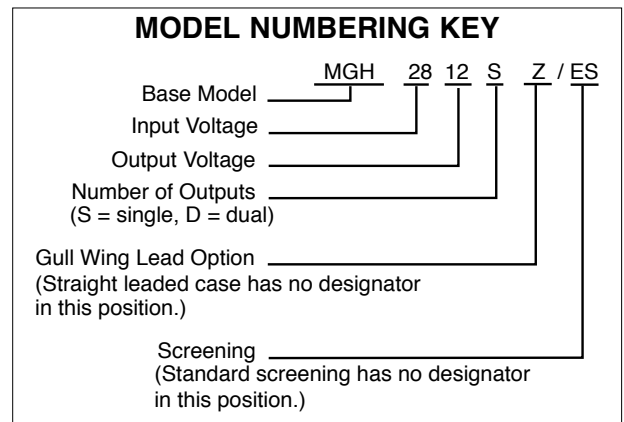

FIGURE 5: MGH MODEL NUMBERING KEY

MODEL NUMBER OPTIONS					
TO DETERMINE THE MODEL NUMBER ENTER ONE OPTION FROM EACH CATEGORY IN THE FORM BELOW.					
CATEGORY	Base Model and Input Voltage	Output Voltage	Number of Outputs ¹	Case Options ²	Screening ³
OPTIONS	MCH	05, 12, 15	S	MCH – down-leaded: leave blank	(standard, leave blank)
	MGH	05, 12, 15	D	MGH – straight leads: leave blank MGH – gull wings: Z	ES 883
FILL IN FOR MODEL #	<u> </u> M <u> </u> H <u> </u>	<u> </u>	<u> </u>	<u> </u>	/ <u> </u>

Notes:

- Number of Outputs: S is a single output and D is a dual output
- Case Options: For the standard case MCH down-leaded case leave the case option blank. For the MGH straight-lead case, leave the case option blank. For the MGH, surface mount gull-wing case, insert the letter "Z" in the case option position.
- Screening: For standard screening leave the screening option blank. For other screening options, insert the desired screening level. For more information see "Table 11: Element Evaluation" on page 12 and "Table 12: Environmental Screening" on page 13.

TABLE 7: MCH/MGH SMD MODEL NUMBER OPTIONS

MCH/MGH Single and Dual DC-DC Converters

28 VOLT INPUT – 1.5 WATT

TABLE 8: OPERATING CONDITIONS, ALL MODELS : 25°C TC, 28 VDC VIN, 100% LOAD, UNLESS OTHERWISE SPECIFIED.

PARAMETER	CONDITIONS	ALL MODELS			UNITS
		MIN	TYP	MAX	
LEAD SOLDERING TEMPERATURE ¹	10 SECONDS MAX.	—	—	300	°C
SURFACE MOUNT SOLDER REFLOW ^{1, 2}	SN 60, 62 OR 63 RECOMMENDED	220°C for max. of 30 seconds			
STORAGE TEMPERATURE ¹		-65	—	+150	°C
CASE OPERATING TEMPERATURE	FULL POWER	-55	—	+125	°C
	ABSOLUTE ¹	-55	—	+135	
DERATING OUTPUT POWER/CURRENT ¹	LINEARLY	From 100% at 125°C to 0% at 135°C			
ISOLATION, ANY PIN TO CASE EXCEPT CASE PIN	@ 500 VDC AT 25°C	100	—	—	Megohms
INPUT TO OUTPUT CAPACITANCE ¹		—	100 - 170	—	pF
UNDERVOLTAGE LOCKOUT ¹		—	8	—	V _{IN}
CURRENT LIMIT ^{1, 3}	% OF FULL LOAD	—	125	—	%
AUDIO REJECTION ¹		—	40	—	dB
CONVERSION FREQUENCY	FREE RUN -55° TO +125°C	270	370	470	kHz
INHIBIT ACTIVE LOW (OUTPUT DISABLED) Do not apply a voltage to the inhibit pin. ⁴	INHIBIT PIN PULLED LOW	—	—	0.8	VDC
	INHIBIT PIN SOURCE CURRENT ¹	—	—	1	mA
	REFERENCED TO	INPUT COMMON			
INHIBIT ACTIVE HIGH (OUTPUT ENABLED) Do not apply a voltage to the inhibit pin. ⁴	INHIBIT PIN CONDITION	OPEN COLLECTOR OR UNCONNECTED			
	OPEN PIN VOLTAGE ¹	7	—	12	V

Notes:

1. Guaranteed by qualification test and/or analysis. Not an in-line test.
2. See "Figure 23: MGH Gull-Wing Solder Pad Layout" on page 11 for more information
3. Dual outputs: The over-current limit will trigger when the sum of the currents from both outputs reaches 125% (typical value) of the maximum rated "total" current of both outputs.
4. An external inhibit interface should be used to pull the inhibit low or leave it floating. The inhibit pin can be left unconnected if not used.

MCH/MGH Single and Dual DC-DC Converters

28 VOLT INPUT – 1.5 WATT

TABLE 9: ELECTRICAL CHARACTERISTICS: -55°C TO +125°C T_C, 28 VDC V_{IN}, 100% LOAD, FREE RUN, UNLESS OTHERWISE SPECIFIED.

MCH/MGH SINGLE OUTPUT MODELS		MCH2805S MGH2805S			MCH2812S MGH2812S			MCH2815S MGH2815S			UNITS
PARAMETER	CONDITIONS	MIN	TYP	MAX	MIN	TYP	MAX	MIN	TYP	MAX	
OUTPUT VOLTAGE ²		4.80	5.00	5.20	11.52	12.00	12.48	14.40	15.00	15.60	VDC
OUTPUT CURRENT	V _{IN} = 12 to 50 VDC	0	—	300	0	—	125	0	—	100	mA
OUTPUT POWER	V _{IN} = 12 to 50 VDC	0	—	1.5	0	—	1.5	0	—	1.5	W
OUTPUT RIPPLE 10 KHZ - 2 MHZ	T _C = 25°C	—	45	150	—	50	200	—	35	150	mV p-p
	T _C = -55°C TO +125°C	—	65	300	—	70	300	—	50	250	
LINE REGULATION	V _{IN} = 12 TO 50 VDC	—	40	120	—	70	250	—	80	350	mV
LOAD REGULATION ³	10% LOAD TO FULL	—	380	800	—	640	1400	—	760	1600	mV
INPUT VOLTAGE	CONTINUOUS	12	28	50	12	28	50	12	28	50	VDC
NO LOAD TO FULL	TRANSIENT ¹ 120 msec.	—	—	80	—	—	80	—	—	70	V
INPUT CURRENT	NO LOAD	—	6.0	11	—	6.5	12	—	6.5	12	mA
	INHIBITED	—	2.4	3.5	—	2.4	3.5	—	2.4	3.5	
INPUT RIPPLE CURRENT ⁴	10 kHz - 10 MHz	—	130	250	—	150	250	—	150	250	mA p-p
EFFICIENCY	T _C = 25°C	72	77	—	74	79	—	74	79	—	%
	T _C = -55°C TO +125°C	69	75	—	72	77	—	72	77	—	
LOAD FAULT ^{5, 6}	POWER DISSIPATION	—	1.4	2.3	—	2.2	3.5	—	2.5	4.0	W
SHORT CIRCUIT	RECOVERY ¹	—	3.5	15	—	3.5	20	—	4.0	20	ms
STEP LOAD RESPONSE ⁷ 50% - 100% - 50%	TRANSIENT	—	±185	±500	—	±380	±800	—	±380	±800	mV pk
	RECOVERY	—	125	600	—	130	600	—	180	750	μs
STEP LINE RESPONSE ^{1, 7} 12 - 50 - 12 VDC	TRANSIENT	—	180	±500	—	±400	±1000	—	±450	±850	mV pk
	RECOVERY	—	0.75	4.0	—	0.6	3.0	—	0.5	2.5	ms
START-UP	DELAY	—	10	40	—	10	40	—	10	40	ms
0 - 28 V _{IN} , FULL LOAD	OVERSHOOT ¹	—	0	150	—	0	350	—	0	450	mV pk
CAPACITIVE LOAD ¹ T _C = 25°C	NO EFFECT ON DC PERFORMANCE	—	—	200	—	—	200	—	—	200	μF

Notes:

1. Guaranteed by qualification test and/or analysis. Not an in-line test.
2. Specified at 50% total P_{out}.
3. Although no minimum load is required, at no load the output voltage may increase up to 15%.
4. An external 2 μH inductor, added in series to the input, is necessary to maintain specifications.

5. Maximum duration of short circuit: 25°C – 90 seconds, 125°C – 30 seconds.
6. Load fault is a short circuit (<50 mohms). Recovery is into resistive full load.
7. Transition ≥ 10 μs. Recovery = time to settle to within 1% of V_{out} final value.

MCH/MGH Single and Dual DC-DC Converters

28 VOLT INPUT – 1.5 WATT

TABLE 10: ELECTRICAL CHARACTERISTICS: -55°C TO +125°C T_C, 28 VDC V_{IN}, 100% LOAD, FREE RUN, UNLESS OTHERWISE SPECIFIED.

MCH/MGH DUAL OUTPUT MODELS		MCH2805D MGH2805D			MCH2812D MGH2812D			MCH2815D MGH2815D			UNITS
PARAMETER	CONDITIONS	MIN	TYP	MAX	MIN	TYP	MAX	MIN	TYP	MAX	
OUTPUT VOLTAGE ²	±V _{OUT}	4.80	5.00	5.20	11.52	12.00	12.48	14.40	15.00	15.60	VDC
OUTPUT CURRENT ³ V _{IN} = 12 to 50 VDC	EACH OUTPUT	0	±150	240	0	±62.5	100	0	±50	80	mA
	TOTAL OUTPUT	—	—	300	—	—	125	—	—	100	
OUTPUT POWER ³ V _{IN} = 12 to 50 VDC	EACH OUTPUT	0	±0.75	1.2	0	±0.75	1.2	0	±0.75	1.2	W
	TOTAL OUTPUT	—	—	1.5	—	—	1.5	—	—	1.5	
OUTPUT RIPPLE 10 KHZ - 2 MHZ ± V _{OUT}	T _C = 25°C	—	35	150	—	35	150	—	30	150	mV p-p
	T _C = -55°C TO +125°C	—	50	250	—	40	250	—	35	250	
LINE REGULATION ±V _{OUT}	V _{IN} = 12 TO 50 V	—	20	100	—	110	400	—	180	650	mV
LOAD REGULATION ⁴ ±V _{OUT}	10% LOAD TO FULL	—	350	700	—	570	1200	—	630	1400	mV
CROSS REGULATION ⁵	-V _{OUT}	—	—	400	—	—	500	—	—	500	mV
INPUT VOLTAGE NO LOAD TO FULL	CONTINUOUS	12	28	50	12	28	50	12	28	50	VDC
	TRANSIENT ¹ 120 msec.	—	—	80	—	—	80	—	—	70	V
INPUT CURRENT	NO LOAD	—	6.0	12	—	8.0	14	—	8.0	14	mA
	INHIBITED	—	2.4	3.5	—	2.4	3.5	—	2.4	3.5	
INPUT RIPPLE CURRENT ⁶	10 kHz - 10 MHz	—	130	250	—	150	250	—	150	250	mA p-p
EFFICIENCY	T _C = 25°C	73	77	—	73	77	—	72	76	—	%
	T _C = -55°C TO +125°C	70	75	—	70	75	—	69	74	—	
LOAD FAULT ^{7, 8}	POWER DISSIPATION	—	1.6	2.5	—	2.7	4.2	—	3.0	4.5	W
SHORT CIRCUIT	RECOVERY ¹	—	3.8	20	—	3.2	20	—	4.0	20	ms
STEP LOAD RESPONSE ⁹ 50% - 100% - 50%	TRANSIENT	—	±140	±400	—	±260	±700	—	±270	±700	mV pk
	RECOVERY	—	100	500	—	165	800	—	50	300	μs
STEP LINE RESPONSE ^{1, 9} 12 - 50 - 12 VDC	TRANSIENT	—	±130	±300	—	±250	±600	—	±230	±600	mV pk
	RECOVERY	—	0.6	3.0	—	0.9	4.0	—	0.7	4.0	ms
START-UP 0 TO 28 V _{IN} , FULL LOAD	DELAY	—	10	45	—	10	45	—	10	45	ms
	OVERSHOOT ¹	—	0	150	—	0	350	—	0	900	mV pk
CAPACITIVE LOAD ¹ T _C = 25°C	NO EFFECT ON DC PERFORMANCE	—	—	100	—	—	100	—	—	100	μF

Notes:

1. Guaranteed by qualification test and/or analysis. Not an in-line test.
2. Specified at 50% total P_{OUT} with balanced loads.
3. Up to 80% of the total output current/power is available from either output providing the opposite output carries a minimum of 20% total load.
4. Although no minimum load is required, at no load the output voltage may increase up to 15%.
5. Cross regulation is specified as the effect on -V_{out} for the following percentages of total output power: +P_o = 20% and -P_o = 80% to +P_o=80% and -P_o=20%

6. An external 2 μH inductor, added in series to the input, is necessary to maintain specifications.

7. Maximum duration of short circuit: 25°C – 90 seconds, 125°C – 30 seconds.

8. Load fault is a short circuit (<50 mohms). Recovery is into resistive full load.

9. Transition ≥ 10 μs. Recovery = time to settle to within 1% of V_{out} final value.

MCH/MGH Single and Dual DC-DC Converters

28 VOLT INPUT – 1.5 WATT

Typical Performance Curves: 25°C Tc, 28 VDC Vin, 100% load, unless otherwise specified.

MCH AND MGH SINGLE AND DUAL OUTPUT MODELS

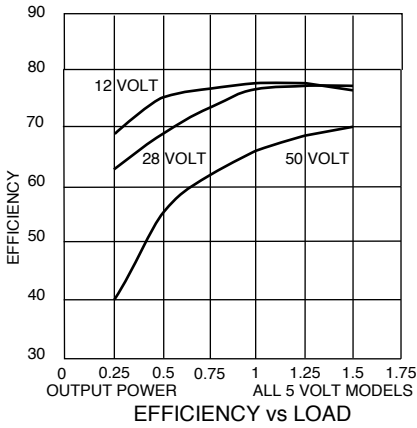

FIGURE 6

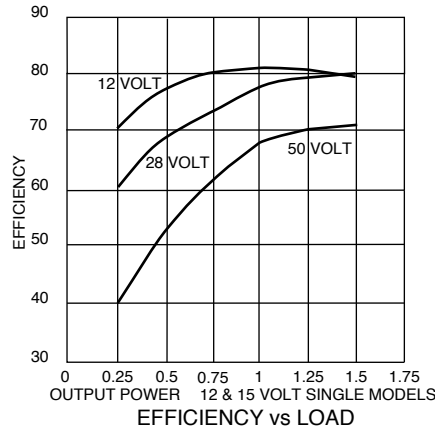

FIGURE 7

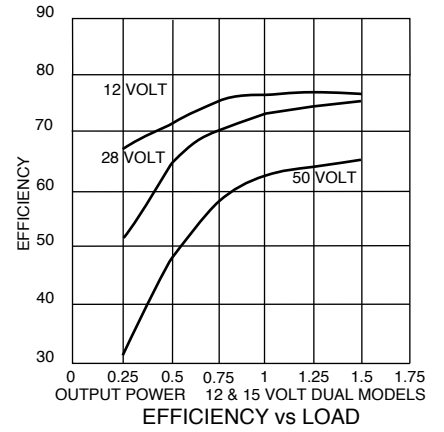

FIGURE 8

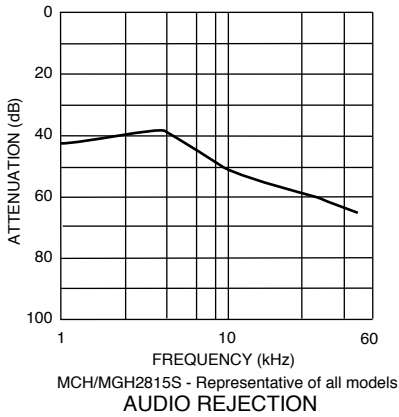

FIGURE 9

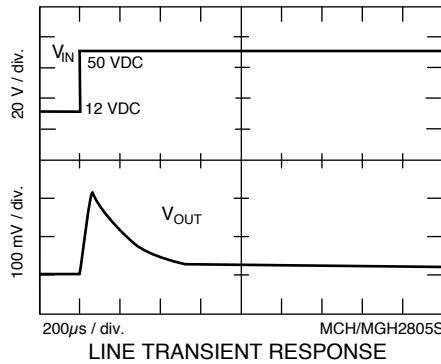

FIGURE 10

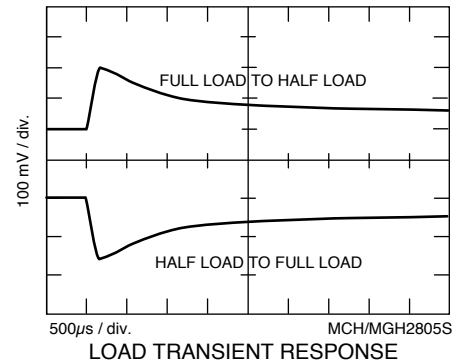

FIGURE 11

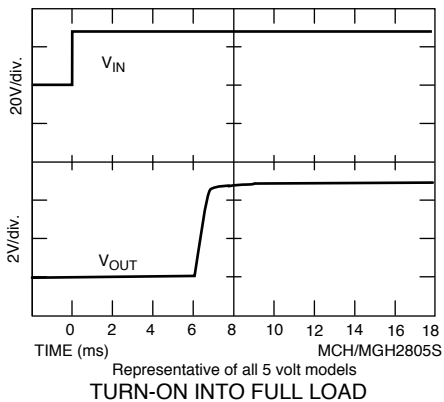

FIGURE 12

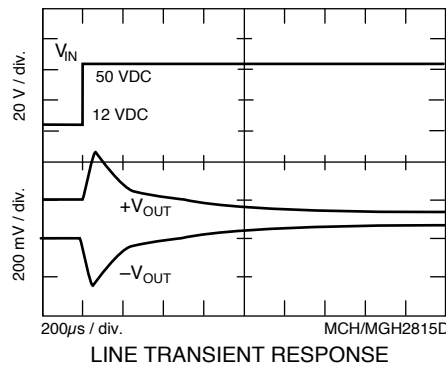

FIGURE 13

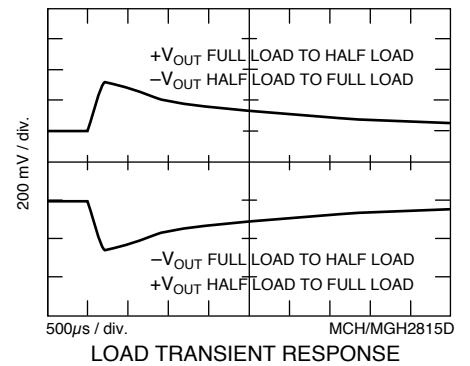

FIGURE 14

MCH/MGH Single and Dual DC-DC Converters

28 VOLT INPUT – 1.5 WATT

Typical Performance Curves: 25°C Tc, 28 VDC Vin, 100% load, unless otherwise specified.

MCH AND MGH SINGLE AND DUAL OUTPUT MODELS (CONT.)

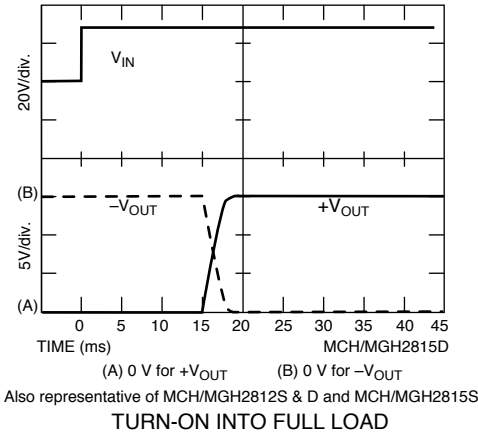

FIGURE 15

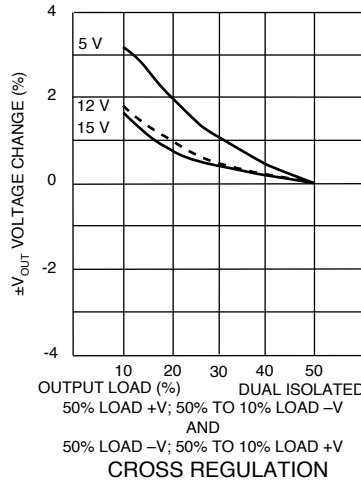

FIGURE 16

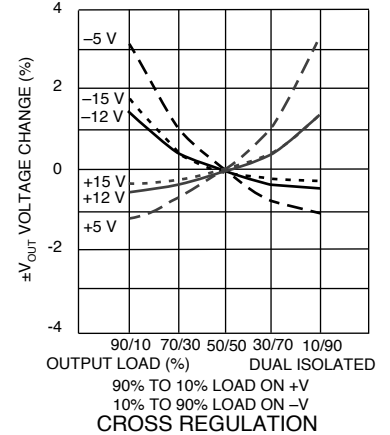

FIGURE 17

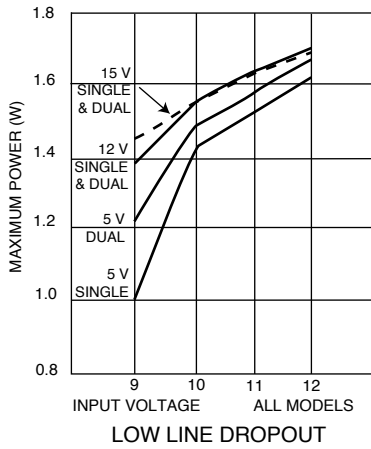

FIGURE 18

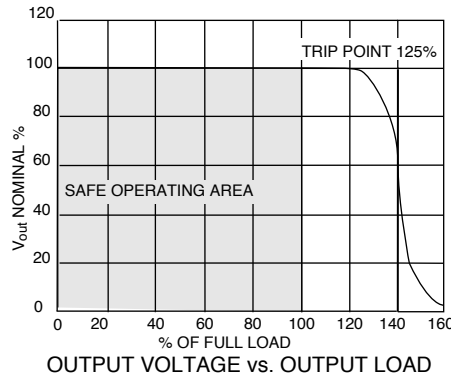

FIGURE 19

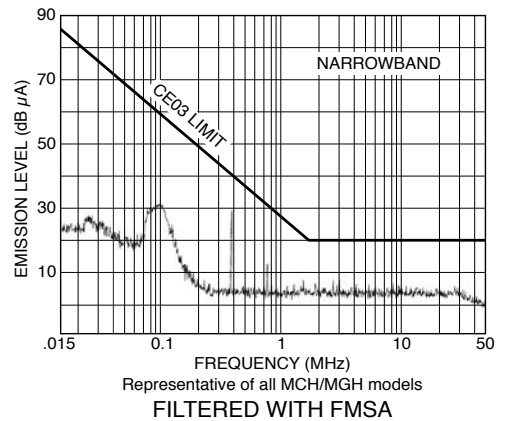
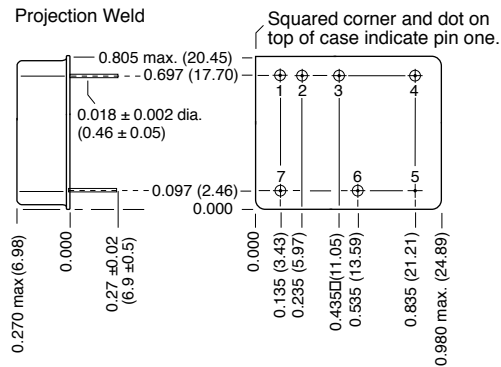

FIGURE 20

MCH/MGH Single and Dual DC-DC Converter Cases

28 VOLT INPUT – 1.5 WATT

BOTTOM VIEW CASE A2



Weight 12 grams typical

Case dimensions in inches (mm)

Tolerance ±0.005 (0.13) for three decimal places
 ±0.01 (0.3) for two decimal places
 unless otherwise specified

CAUTION

Solder pins individually with heat application not exceeding 300°C for 10 seconds per pin.

Materials

Header Kovar/Nickel/Gold
 Cover Kovar/Nickel
 Pins Kovar/Nickel/Gold matched glass seal
 Gold plating of 50 - 225 microinches
 included in pin diameter
 Seal hole: 0.056 ± 0.002 (1.42 ± 0.05)

Case A2, Rev G, 2013.04.15

Please refer to the numerical dimensions for accuracy.

FIGURE 21: MCH CASE DIMENSIONS

DOWN-LEADED CASE

MCH/MGH Single and Dual DC-DC Converter Cases

28 VOLT INPUT – 1.5 WATT

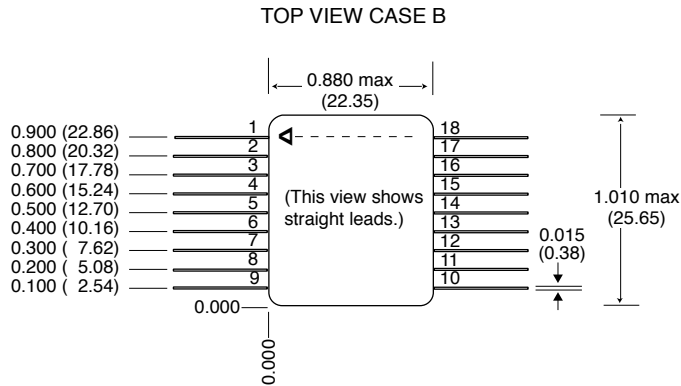

CASE B1 GULL-WING SOLDER PADS

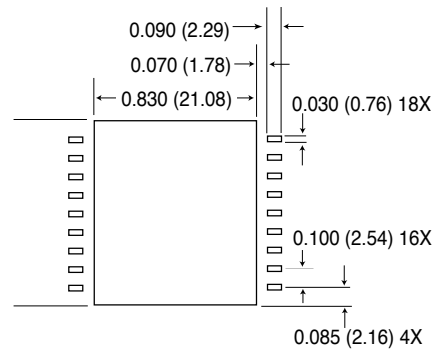

The triangle (ESD) marking on the cover indicates pin one. Cover marking is oriented with pin one at the upper right corner. The straight lead configuration does not require a “case designator” in the model number. ex. MGH2805S

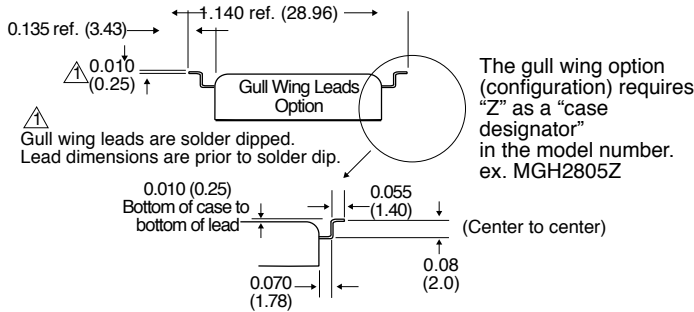
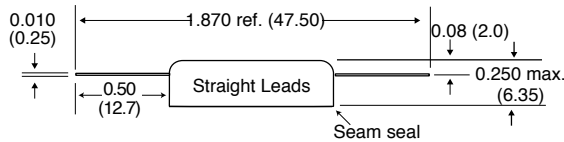

Weight 12 grams maximum

Case dimensions in inches (mm)

Tolerance ± 0.005 (0.13) for three decimal places, ± 0.01 (0.3) for two decimal places unless otherwise specified. Please refer to the numerical dimensions for accuracy.

CAUTION

Maximum reflow temperature is 220°C for a maximum of 30 seconds. SN60, SN62, or SN63 are the recommended types of solder. See MGH gull-wing solder pad layout. Hand soldering should not exceed 300°C for 10 seconds per pin.

Materials

- Header Kovar/Nickel/Gold
- Cover Kovar/Nickel
- Pins Kovar/Nickel/Gold matched glass seal
- Gold plating of 50 - 150 microinches is included in pin diameter
- Seal hole: 0.040 \pm 0.002 (1.02 \pm 0.05)

Case B, Rev D, 2013.04.15

FIGURE 22: MGH CASE DIMENSIONS

Dimensions in inches (mm)

Tolerance ± 0.005 (0.13) for three decimal places ± 0.01 (0.3) for two decimal places, unless otherwise specified. Please refer to the numerical dimensions for accuracy.

CAUTION:

Internal components are soldered with SN96 (melting temperature 221°C) to prevent damage during reflow. Maximum reflow temperature for surface mounting the MGH converter is 220°C for a maximum of 30 seconds. SN60, 62, or 63 are the recommended types of solder. Hand soldering should not exceed 300°C for 10 seconds per pin.

SOLDER MASK NOTES

1. Pad dimensions are for the solder mask. Leads common to each other can be connected to each other as desired.
2. Ground (case) pins should be connected to the center pad for improved grounding.
3. Connect "no connection" pins to case ground to reduce EMI.
4. Center pad should not have a solder mask.
5. Adhesive attach is intended to be a surface for soldering the hybrid to the circuit board.
6. Pre-tin base of converter prior to soldering.
7. If less rotation of case is desired, reduce the width of the large case pad by 0.020 inches (0.51 mm). Pad length can be extended 0.010 inches (0.25 mm) towards the case body and an as-desired dimension away from the case body.
8. Do not exceed 220°C as measured on the body of the converter (top or bottom).
9. Attach the body of the case to the board with a thermally conductive adhesive or SN60, 62, or 63 solder. The adhesive can be electrically conductive as well. It can be applied as an underfill post solder or dispensed and cured prior or during solder.
10. In the presence of vibration, to ensure reliable mechanical attachment, the body of the case should be attached with adhesive or solder as noted above (note 7). The leads alone do not provide sufficient mechanical attachment.

Case B1 MGH Solder Pads, Rev F, 2013.05.31

FIGURE 23: MGH GULL-WING SOLDER PAD LAYOUT

SURFACE MOUNT CASE AND LEAD OPTIONS

MCH/MGH Single and Dual DC-DC Converters

28 VOLT INPUT – 1.5 WATT

STANDARD AND /ES (NON-QML) AND /883 (CLASS H, QML) MIL-PRF-38534 ELEMENT EVALUATION

COMPONENT-LEVEL TEST PERFORMED	NON-QML ¹		QML	
	STANDARD AND /ES		CLASS H /883	
	M/S ²		M/S ²	P ³
Element Electrical	■		■	■
Visual			■	■
Internal Visual			■	
Final Electrical			■	■
Wire Bond Evaluation			■	■

Notes:

1. Standard and /ES non-QML products may not meet all of the requirements of MIL-PRF-38534.
2. M/S = Active components (Microcircuit and Semiconductor Die)
3. P = Passive components, Class H element evaluation. Not applicable to Standard and /ES element evaluation.

TABLE 11: ELEMENT EVALUATION

MCH/MGH Single and Dual DC-DC Converters

28 VOLT INPUT – 1.5 WATT

STANDARD AND /ES (NON-QML) AND /883 (CLASS H, QML) MIL-PRF-38534 ENVIRONMENTAL SCREENING

TEST PERFORMED	NON-QML ¹		QML
	STANDARD	/ES	CLASS H /883
Pre-cap Inspection, Method 2017, 2032	■	■	■
Temperature Cycle (10 times)			
Method 1010, Cond. C, -65°C to +150°C, ambient			■
Method 1010, Cond. B, -55°C to +125°C, ambient		■	
Constant Acceleration			
Method 2001, 3000 g			■
Method 2001, 500 g		■	
Burn-in Method 1015, +125°C case, typical ²			
96 hours		■	
160 hours			■
Final Electrical Test, MIL-PRF-38534, Group A,			
Subgroups 1 through 6, -55°C, +25°C, +125°C case			■
Subgroups 1 and 4, +25°C case	■	■	■
Hermeticity Test			
Gross Leak, Method 1014, Cond. C		■	■
Fine Leak, Method 1014, Cond. A		■	■
Gross Leak, Dip	■		
Final visual inspection, Method 2009	■	■	■

Test methods are referenced to MIL-STD-883 as determined by MIL-PRF-38534.

Notes:

- Standard and /ES, non-QML products, may not meet all of the requirements of MIL-PRF-38534.
- Burn-in temperature designed to bring the case temperature to +125°C minimum. Burn-in is a powered test.

TABLE 12: ENVIRONMENTAL SCREENING