

# SMHF42 Single and Dual DC-DC Converters

## 35-55 VOLT INPUT – 15 WATT

### FEATURES

- Radiation tolerant space DC-DC converter
  - Single event effects (SEE) LET performance to 86 MeV cm<sup>2</sup>/mg<sup>1</sup>
  - Total ionizing dose (TID) guaranteed per MIL-STD-883 method 1019, radiation hardness assurance (RHA)<sup>1</sup> L = 50 krad(Si), R = 100 krad(Si)
  - 50 - 300 rad(Si)/sec dose rate (Condition A)<sup>1</sup>
  - 10 mrad(Si)/sec dose rate (Condition D)<sup>1</sup>
- Operating temperature -55°C to +125°C
- Screened to MIL-PRF-38534 Class H and K<sup>1</sup>
- Input voltage range 35 to 55 volts
- Transient protection 80 volts for 50 ms
- Fully isolated
- Fixed high frequency switching
- Inhibit function
- Synchronization input
- Indefinite short circuit protection
- Undervoltage lockout



MODELS	
OUTPUT VOLTAGE (V)	
SINGLE	DUAL
3.3	±5
5	±7
5.2	±12
12	±15
15	

### DESCRIPTION

The Interpoint® SMHF42 Series™ of 42 volt DC-DC converters offers up to 15 watts of power in a radiation tolerant design. The low profile SMHF42 converters are manufactured in our fully certified and qualified MIL-PRF-38534 Class K production facility and packaged in hermetically sealed steel cases. They are ideal for use in programs requiring high reliability, small size, and high levels of radiation hardness assurance. They are targeted for operation on a 42 volt satellite power bus. The units are capable of withstanding transients up to 80 volts for up to 50 ms.

### SCREENING

SMHF42 converters offer screening to Class H or K and radiation hardness assurance (RHA) levels L - 50 krad(Si) or R - 100 krad(Si). Single event effects (SEE) LET<sup>1</sup> performance to 86 MeV cm<sup>2</sup>/mg. See Table 11 on page 35 for more information. The converters are screened to MIL-PRF-38534. Class H, Class K, RHA L, RHA R, and SEE are pending product validation.

### CONVERTER DESIGN

The SMHF42 converters are switching regulators that use a quasi-square wave, single-ended forward converter design with a constant switching frequency of 500 kHz typical. Isolation between input and output circuits is provided with a transformer in the forward path and a temperature compensated opto-coupler in the feedback control loop. The opto-coupler is radiation tolerant and is especially selected for space applications.

Dual output models maintain cross regulation with tightly coupled output magnetics. Up to 70% of the total output power is available from either output, providing the opposite output is simultaneously carrying 30% of the total output power. Predictable current limit is accomplished by directly monitoring the output load current and providing a constant current output above the overload point.

Feed-forward compensation system provides excellent dynamic response and audio rejection. Audio rejection is typically 50 dB. Typical output voltage response for a 50% to 100% step load transient is as low as 2% with a 100 μs recovery time, typical.

### INHIBIT FUNCTION

An inhibit terminal that can be used to disable internal switching, resulting in no output and very low quiescent input current. The converter is inhibited when the inhibit pin is pulled low. The unit is enabled when the pin, which is internally connected to a pull-up resistor, is left unconnected or is connected to an open-collector gate.

### SYNCHRONIZATION

Synchronization allows the user to synchronize the switching frequency of the converter to the frequency of the system clock. This allows the user to adjust the nominal 500 kHz operating frequency to any frequency within the range of 500 kHz to 600 kHz by applying a compatible input of the desired frequency to pin 5.

1. Screened to MIL-PRF-38534. Class H, Class K, RHA L, RHA R, and SEE are pending product validation.

# SMHF42 Single and Dual DC-DC Converters

## 35-55 VOLT INPUT – 15 WATT

### SHORT CIRCUIT PROTECTION

Short circuit protection is provided by restricting the output current to approximately 140% of the full load output current. The output current is sensed in the secondary stage to provide highly predictable and accurate current limiting, and to eliminate foldback characteristics.

### UNDERVOLTAGE LOCKOUT

Undervoltage lockout prevents the converters from operating below approximately 30 volts input to keep system current levels smooth, especially during initialization or re-start operations.

### EXTERNAL EMI FILTER

The Interpoint SFMC28-461™ EMI filter reduces the input line reflected ripple current of the SMHF42 converters to meet MIL-STD-461C levels of conducted emission (CE01, CE03). The maximum input voltage of the SFMC28-461 is 50 volts.

Example EMI plots are Figure 8, Figure 20, Figure 32, Figure 44, Figure 57 and Figure 70.

### SPAN VOLTAGE ON DUALS

Dual outputs may be spanned to increase the output voltage. Our duals can also be configured as a single output where the positive output is used as one rail and the negative output is used as the other rail. As an example the positive and negative 15 volt dual can be configured as a single 30 volt output. This can be used as a positive 30 volt output or a negative 30 volt output. In all cases Output Common of the converter is not connected.

If the dual is configured as a positive 30 volt output the negative output would be used as system ground and the positive output would be used as the positive 30 volt output.

The maximum capacitance when using a span voltage on a dual is half the value specified for each output.

# SMHF42 Single and Dual DC-DC Converters

35-55 VOLT INPUT – 15 WATT

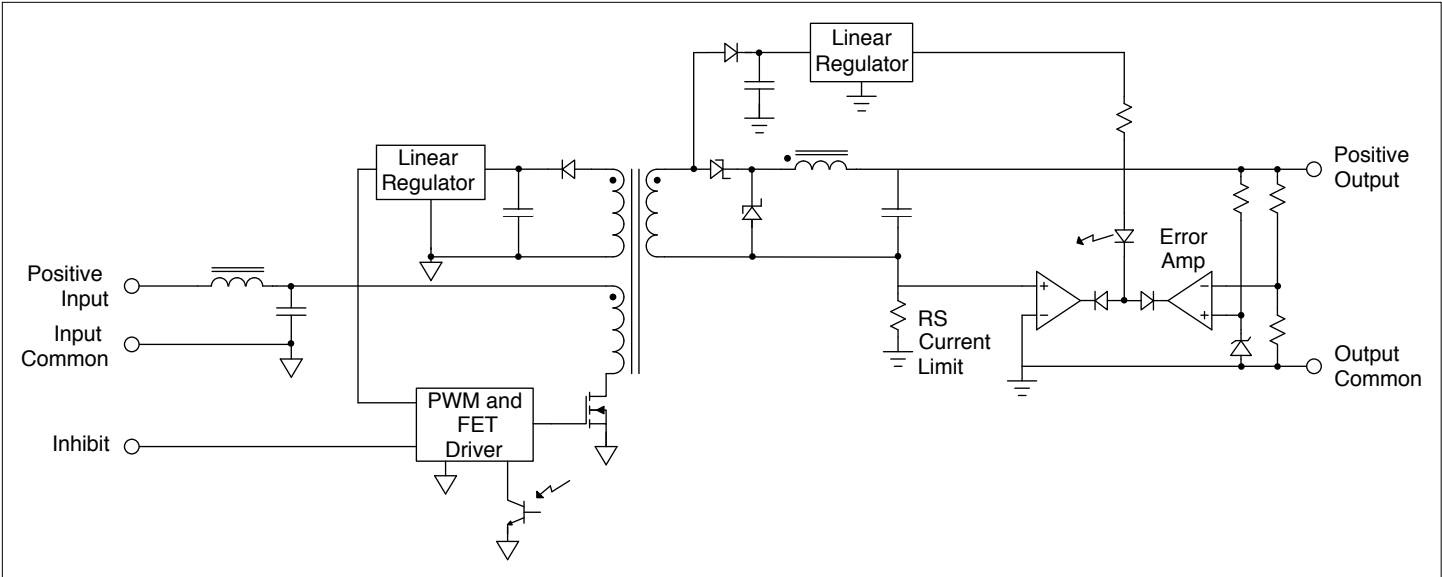

FIGURE 1: SMHF42 SINGLE OUTPUT, BLOCK DIAGRAM

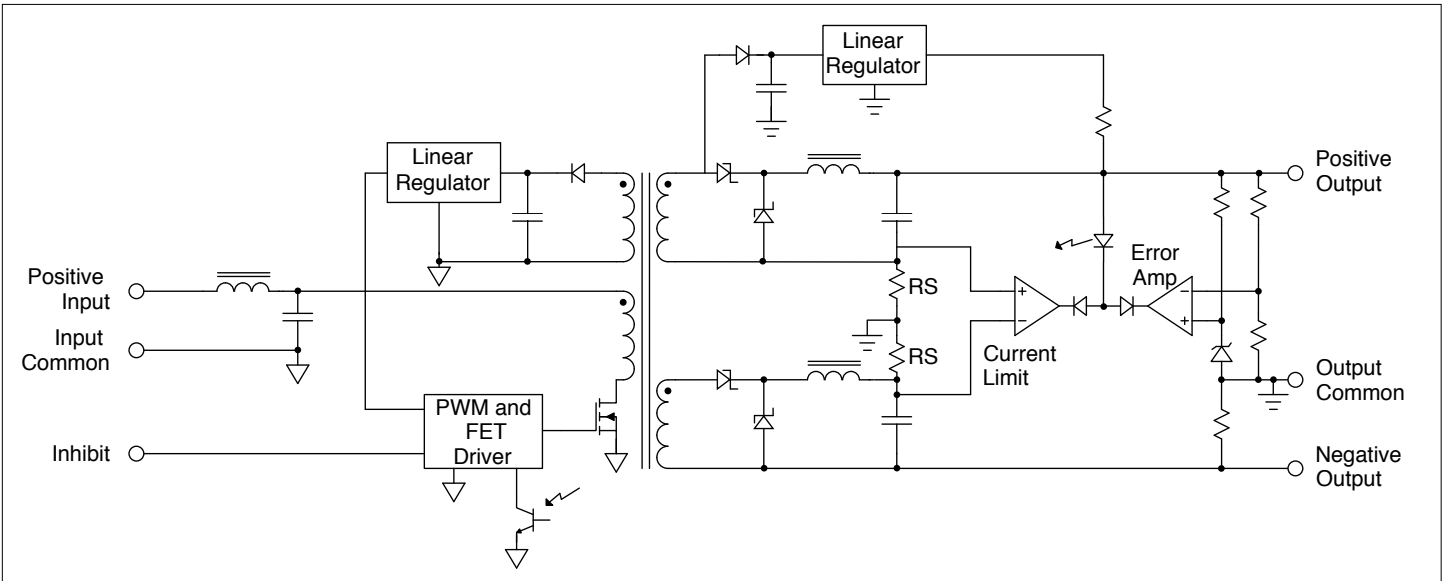

FIGURE 2: SMHF42 DUAL OUTPUT, BLOCK DIAGRAM

# SMHF42 Single and Dual DC-DC Converters

## 35-55 VOLT INPUT – 15 WATT

PIN OUT		
Pin	Single Output	Dual Output
1	Inhibit	Inhibit
2	No connection	Positive Output
3	Output Common	Output Common
4	Positive Output	Negative Output
5	Sync	Sync
6	Case Ground	Case Ground
7	Input Common	Input Common
8	Positive Input	Positive Input

TABLE 1: PIN OUT

SMD NUMBERS	
STANDARD MICROCIRCUIT DRAWING (SMD)	SMHF42 SIMILAR PART
5962R1722701KXC IN PROCESS	SMHF423R3S/KR
5962R1722702KXC IN PROCESS	SMHF4205S/KR
5962R1722703KXC IN PROCESS	SMHF425R2S/KR
5962R1722704KXC IN PROCESS	SMHF4212S/KR
5962R1722705KXC IN PROCESS	SMHF4215S/KR
5962R1722801KXC IN PROCESS	SMHF4205D/KR
5962R1722802KXC IN PROCESS	SMHF4207D/KR
5962R1722803KXC IN PROCESS	SMHF4212D/KR
5962R1722804KXC IN PROCESS	SMHF4215D/KR

To indicate the flanged case option change the "X" to "Z" in the SMD number. The SMD number shown is for Class K screening, non-flanged, and radiation hardness assurance (RHA) level R. See the SMD for the numbers for other screening and radiation levels. For exact specifications for an SMD product, refer to the SMD drawing. SMDs can be downloaded from <http://www.landandmaritime.dla.mil/programs/smcr/>

TABLE 2: SMD NUMBER CROSS REFERENCE

PINS NOT IN USE	
Inhibit (pin 1)	Leave unconnected
Sync (pin 5)	Connect to Input Common (pin 7)

TABLE 3: PINS NOT IN USE

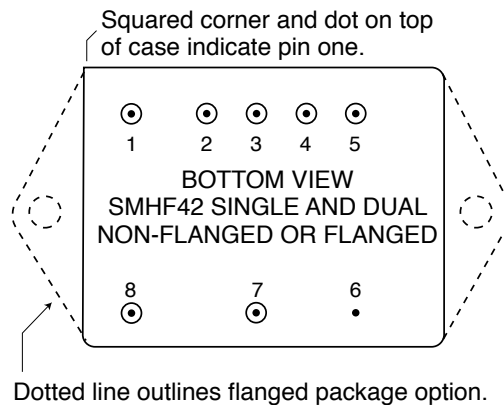

See Figure 80 on page 32 and Figure 81 on page 33 for dimensions.

# SMHF42 Single and Dual DC-DC Converters

## 35-55 VOLT INPUT – 15 WATT

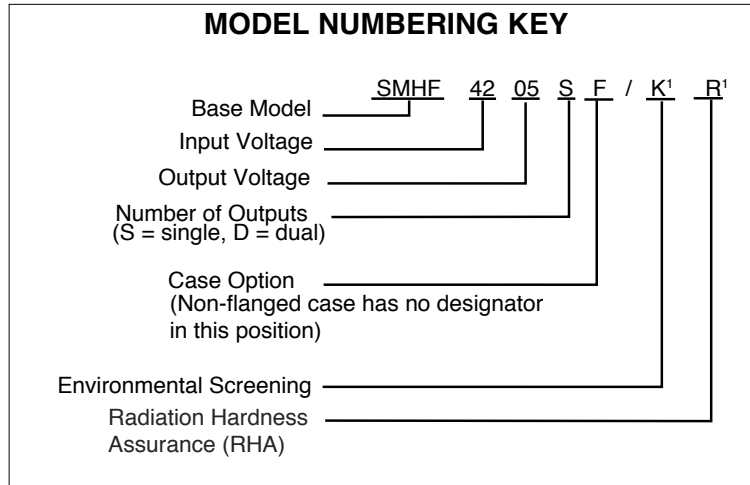

FIGURE 4: MODEL NUMBERING KEY

1. Screened to MIL-PRF-38534. Class H, Class K, RHA L, RHA R, and SEE are pending product validation.

MODEL NUMBER OPTIONS <sup>1</sup>						
TO DETERMINE THE MODEL NUMBER ENTER ONE OPTION FROM EACH CATEGORY IN THE FORM BELOW.						
CATEGORY	Base Model and Input Voltage	Output Voltage <sup>2</sup>	Number of Outputs <sup>3</sup>	Case Option <sup>4</sup>	Screening <sup>5</sup>	RHA <sup>6</sup>
OPTIONS	SMHF42	3R3, 05, 5R2, 12, 15	S	(non-flanged, leave blank)	O	O
		05, 07, 12, 15	D	F (flanged)	H K	L R
FILL IN FOR MODEL # <sup>7</sup>	<u>SMHF42</u>	_____	_____	_____ / _____	_____	_____

Notes

- See Figure 4 above for an example of a model number.
- Output Voltage: An R indicates a decimal point. 3R3 is 3.3 volts out. The values of 3.3 and 5.2 are only available in single output models.
- Number of Outputs: S is a single output and D is a dual output
- Case Options: For the standard case (Figure 80 on page 32) leave the Case Option blank. For the flanged case option (Figure 81 on page 33), insert the letter F in the Case Option position.
- Screening: Screened to MIL-PRF-38534. Class H and K are pending product validation. A screening level of O is a space prototype and is only available with RHA O. See Table 10 on page 34 and Table 11 on page 35 for more information.
- RHA: Screened to MIL-PRF-38534. RHA L, RHA R and SEE are pending product validation. Interpoint model numbers use an "O" in the RHA designator position to indicate the "-" (dash) radiation hardness assurance level of MIL-PRF-38534, which is defined as "no RHA." RHA O is only available with screening level O. See Table 12 on page 36 for more information.
- If ordering by model number add a "-Q" to request solder dipped leads (SMHF4205S/KR-Q). Available only for Class H and K

TABLE 4: MODEL NUMBER OPTIONS

# SMHF42 Single and Dual DC-DC Converters

## 35-55 VOLT INPUT – 15 WATT

TABLE 5: OPERATING CONDITIONS - ALL MODELS, 25°C CASE, 42 VIN, UNLESS OTHERWISE SPECIFIED

SMHF42 SERIES		ALL MODELS			UNITS
PARAMETER	CONDITIONS	MIN	TYP	MAX	
LEAD SOLDERING TEMPERATURE <sup>1</sup>	10 SECONDS MAX.	–	–	300	°C
STORAGE TEMPERATURE <sup>1</sup>		-65	–	+150	°C
CASE OPERATING TEMPERATURE	FULL POWER	-55	–	+125	°C
	ABSOLUTE <sup>1</sup>	-55	–	+135	
DERATING OUTPUT POWER/CURRENT <sup>1</sup>	LINEARLY	From 100% at 125°C to 0% at 135°C			
ESD RATING <sup>1, 2</sup> MIL-PRF-38534, 3.9.5.8.2	MIL-STD-883 METHOD 3015 CLASS 1C	1000-1999			V
ISOLATION: INPUT TO OUTPUT OR ANY PIN TO CASE EXCEPT CASE PIN	@ 500 VDC AT 25°C	100	–	–	Megohms
UNDERVOLTAGE LOCKOUT <sup>1</sup>	V <sub>IN</sub>	–	30	–	V
INPUT TO OUTPUT CAPACITANCE <sup>1</sup>		–	60	–	pF
CURRENT LIMIT <sup>1, 3</sup>	% OF FULL LOAD	–	140	–	%
AUDIO REJECTION <sup>1</sup>		–	50	–	dB
SWITCHING FREQUENCY	-55°C TO +125°C	480	500	620	kHz
SYNCHRONIZATION	INPUT FREQUENCY	500	–	600	kHz
	DUTY CYCLE <sup>1</sup>	40	–	50	%
	ACTIVE LOW	–	–	0.8	V
	ACTIVE HIGH <sup>1</sup>	4.5	–	5.0	
	REFERENCED TO	INPUT COMMON			
	IF NOT USED	CONNECT TO INPUT COMMON			
INHIBIT ACTIVE LOW (OUTPUT DISABLED) Do not apply a voltage to the inhibit pin	INHIBIT PIN PULLED LOW	–	–	0.8	V
	INHIBIT PIN SOURCE CURRENT <sup>1, 4</sup>	–	–	1.5	mA
	REFERENCED TO	INPUT COMMON			
INHIBIT ACTIVE HIGH (OUTPUT ENABLED) Do not apply a voltage to the inhibit pin	INHIBIT PIN CONDITION	OPEN COLLECTOR OR UNCONNECTED			
	OPEN INHIBIT PIN VOLTAGE <sup>1</sup>	7.5	–	12	V

***For mean time between failures (MTBF) contact Applications Engineering  
powerapps@craneae.com +1 425.882.3100***

## Notes

1. Guaranteed by characterization test and/or analysis. Not a production test.
2. Passes 1000 volts.
3. Current limit is defined as the point at which the output voltage decreases by 1%.  
Dual outputs: The over-current limit will trigger when the sum of the currents from both outputs reaches 140% (typical value) of the maximum rated "total" current of both outputs.
4. Inhibit current = Vin/35 k ohms.

# SMHF42 Single and Dual DC-DC Converters

## 35-55 VOLT INPUT – 15 WATT

TABLE 6: ELECTRICAL CHARACTERISTICS: -55°C TO +125°C CASE, 42 VIN, 100% LOAD, UNLESS OTHERWISE SPECIFIED.

SINGLE OUTPUT MODELS		SMHF423R3S			SMHF4205S			SMHF425R2S			UNITS
PARAMETER	CONDITIONS	MIN	TYP	MAX	MIN	TYP	MAX	MIN	TYP	MAX	
OUTPUT VOLTAGE		3.20	3.30	3.40	4.85	5.00	5.15	5.05	5.20	5.35	V
OUTPUT CURRENT	$V_{IN} = 35$ TO 55 V	—	—	2.4	—	—	2.4	—	—	2.4	A
OUTPUT POWER	$V_{IN} = 35$ TO 55 V	0	—	8	0	—	12	0	—	12.5	W
OUTPUT RIPPLE	$T_C = 25^\circ\text{C}$	—	5	50	—	5	50	—	5	50	mV p-p
10 kHz - 2 MHz	$T_C = -55^\circ\text{C}$ TO $+125^\circ\text{C}$	—	5	50	—	5	50	—	5	50	
OUTPUT RIPPLE	$T_C = 25^\circ\text{C}$	—	5	80	—	5	80	—	5	80	mV p-p
10 kHz - 10 MHz	$T_C = -55^\circ\text{C}$ TO $+125^\circ\text{C}$	—	5	80	—	5	80	—	5	80	
LINE REGULATION	$V_{IN} = 35$ TO 55 V	—	1	10	—	1	10	—	1	10	mV
LOAD REGULATION	NO LOAD TO FULL	—	20	50	—	20	50	—	20	50	mV
INPUT VOLTAGE	CONTINUOUS	35	42	55	35	42	55	35	42	55	V
NO LOAD TO FULL	TRANSIENT 50 ms <sup>1</sup>	0	—	80	0	—	80	0	—	80	V
INPUT CURRENT	NO LOAD	—	25	50	—	25	40	—	25	40	mA
	INHIBITED	—	6	10	—	6	10	—	6	10	
INPUT RIPPLE CURRENT	10 kHz - 10 MHz	—	—	120	—	—	120	—	—	120	mA p-p
EFFICIENCY	$T_C = 25^\circ\text{C}$	68	72	—	73	79	—	73	80	—	%
	$T_C = -55^\circ\text{C}$ TO $+125^\circ\text{C}$	65	—	—	70	—	—	70	—	—	
LOAD FAULT <sup>2, 3</sup>	POWER DISSIPATION	—	5	8	—	3.5	8	—	3.5	8	W
SHORT CIRCUIT	RECOVERY <sup>1</sup>	—	7.5	30	—	7.5	30	—	7.5	30	ms
STEP LOAD RESPONSE <sup>3, 4</sup>	TRANSIENT	—	±150	±400	—	±150	±400	—	±150	±400	mV pk
50% - 100% - 50%	RECOVERY	—	150	300	—	150	300	—	150	300	μs
STEP LINE RESPONSE <sup>1, 3, 5</sup>	TRANSIENT	—	±2	±5	—	±2	±5	—	±2	±5	%
± 2 V STEP TRANSIENT <sup>6</sup>	RECOVERY	—	150	—	—	100	—	—	100	—	μs
STARTUP <sup>7, 3</sup>	DELAY	—	10	25	—	10	25	—	10	25	ms
	OVERSHOOT	—	15	50	—	15	50	—	15	50	mV pk
CAPACITIVE LOAD <sup>1</sup>	$T_C = 25^\circ\text{C}$	—	—	300	—	—	300	—	—	300	μF

### Notes

1. Guaranteed by characterization test and/or analysis. Not a production test.
2. Indefinite short circuit protection not guaranteed above 125°C (case)
3. Recovery time is measured from application of the transient to the point at which  $V_{out}$  is within 1% of final value.
4. Step load transition test is performed at 10 microseconds typical.

5. Step line characterization test is performed at 100 microseconds ± 20 microseconds..

6. ± 2 V step transients from  $V_{in}$  35 to 37 up to 55 and the reverse for 55 to 35.

7. Tested on release from inhibit.

# SMHF42 Single and Dual DC-DC Converters

## 35-55 VOLT INPUT – 15 WATT

TABLE 7: ELECTRICAL CHARACTERISTICS: -55°C TO +125°C CASE, 42 VIN, 100% LOAD, UNLESS OTHERWISE SPECIFIED.

SINGLE OUTPUT MODELS		SMHF4212S			SMHF4215S			UNITS
PARAMETER	CONDITIONS	MIN	TYP	MAX	MIN	TYP	MAX	
OUTPUT VOLTAGE		11.76	12.00	12.24	14.70	15.00	15.30	V
OUTPUT CURRENT	$V_{IN} = 35 \text{ TO } 55 \text{ V}$	—	—	1.25	—	—	1.00	A
OUTPUT POWER	$V_{IN} = 35 \text{ TO } 55 \text{ V}$	0	—	15	0	—	15	W
OUTPUT RIPPLE	$T_C = 25^\circ\text{C}$	—	15	40	—	10	40	mV p-p
10 kHz - 2 MHz	$T_C = -55^\circ\text{C TO } +125^\circ\text{C}$	—	15	40	—	10	40	
OUTPUT RIPPLE	$T_C = 25^\circ\text{C}$	—	15	70	—	10	70	mV p-p
10 kHz - 10 MHz	$T_C = -55^\circ\text{C TO } +125^\circ\text{C}$	—	15	70	—	10	70	
LINE REGULATION	$V_{IN} = 35 \text{ TO } 55 \text{ V}$	—	5	20	—	8	30	mV
LOAD REGULATION	NO LOAD TO FULL	—	20	50	—	20	50	mV
INPUT VOLTAGE	CONTINUOUS	35	42	55	35	42	55	V
NO LOAD TO FULL	TRANSIENT 50 ms <sup>1</sup>	0	—	80	0	—	80	V
INPUT CURRENT	NO LOAD	—	25	55	—	25	62	mA
	INHIBITED	—	5	10	—	5	10	
INPUT RIPPLE CURRENT	10 kHz - 10 MHz	—	—	120	—	—	120	mA p-p
EFFICIENCY	$T_C = 25^\circ\text{C}$	76	80	—	78	81	—	%
	$T_C = -55^\circ\text{C TO } +125^\circ\text{C}$	72	—	—	74	—	—	
LOAD FAULT <sup>2,3</sup>	POWER DISSIPATION	—	3.5	8	—	3.5	8	W
SHORT CIRCUIT	RECOVERY <sup>1</sup>	—	7.5	30	—	7.5	30	ms
STEP LOAD RESPONSE <sup>3,4</sup>	TRANSIENT	—	±150	±500	—	±200	±500	mV pk
50% - 100% - 50%	RECOVERY	—	50	300	—	50	300	
STEP LINE RESPONSE <sup>1,3,5</sup>	TRANSIENT	—	±2	±5	—	±2	±5	%
±2 V STEP TRANSIENT <sup>6</sup>	RECOVERY	—	150	—	—	150	—	
STARTUP <sup>7,3</sup>	DELAY	—	10	25	—	10	25	ms
	OVERSHOOT	—	25	50	—	25	50	mV pk
CAPACITIVE LOAD <sup>1</sup>	$T_C = 25^\circ\text{C}$	—	—	100	—	—	100	μF

## Notes

1. Guaranteed by characterization test and/or analysis. Not a production test.
2. Indefinite short circuit protection not guaranteed above 125°C (case)
3. Recovery time is measured from application of the transient to the point at which Vout is within 1% of final value.
4. Step load transition test is performed at 10 microseconds typical.
5. Step line characterization test is performed at 100 microseconds ± 20 microseconds.
6. ± 2 V step transients from Vin 35 to 37 up to 55 and the reverse for 55 to 35.
7. Tested on release from inhibit.



# SMHF42 Single and Dual DC-DC Converters

## 35-55 VOLT INPUT – 15 WATT

TABLE 8: ELECTRICAL CHARACTERISTICS: -55°C TO +125°C CASE, 42 VIN, 100% LOAD, UNLESS OTHERWISE SPECIFIED.

DUAL OUTPUT MODELS		SMHF4205D			SMHF4207D			UNITS
PARAMETER	CONDITIONS	MIN	TYP	MAX	MIN	TYP	MAX	
OUTPUT VOLTAGE	+V <sub>OUT</sub>	4.85	5.00	5.15	6.86	7.00	7.14	V
	-V <sub>OUT</sub>	4.82	5.00	5.18	6.83	7.00	7.18	
OUTPUT CURRENT <sup>2</sup> V <sub>IN</sub> = 35 TO 55 V	EITHER OUTPUT	—	±1.2	1.68	—	±0.850	1.190	A
	TOTAL	—	—	2.4	—	—	1.7	
OUTPUT POWER <sup>2</sup> V <sub>IN</sub> = 35 TO 55 V	EITHER OUTPUT	—	±6	8.4	—	±5.95	8.33	W
	TOTAL	—	—	12	—	—	11.9	
OUTPUT RIPPLE ± V <sub>OUT</sub> 10 kHz - 2 MHz	T <sub>C</sub> = 25°C	—	30	95	—	20	95	mV p-p
	T <sub>C</sub> = -55°C TO +125°C	—	30	95	—	20	95	
OUTPUT RIPPLE ± V <sub>OUT</sub> 10 kHz - 10 MHz	T <sub>C</sub> = 25°C	—	30	110	—	20	110	mV p-p
	T <sub>C</sub> = -55°C TO +125°C	—	30	110	—	20	110	
LINE REGULATION <sup>3</sup> V <sub>IN</sub> = 35 TO 55 V	+V <sub>OUT</sub>	—	2	10	—	2	10	mV
	-V <sub>OUT</sub>	—	10	100	—	10	100	
LOAD REGULATION <sup>3</sup> NO LOAD TO FULL	+V <sub>OUT</sub>	—	5	25	—	5	20	mV
	-V <sub>OUT</sub>	—	80	150	—	100	200	
CROSS REGULATION <sup>4</sup>	EFFECT ON -V <sub>OUT</sub>	—	—	375	—	—	700	mV
INPUT VOLTAGE NO LOAD TO FULL	CONTINUOUS	35	42	55	35	42	55	V
	TRANSIENT 50 ms <sup>1</sup>	—	—	80	—	—	80	V
INPUT CURRENT	NO LOAD	—	25	50	—	25	60	mA
	INHIBITED	—	6	10	—	6	10	
INPUT RIPPLE CURRENT	10 kHz - 10 MHz	—	60	120	—	60	120	mA p-p
EFFICIENCY	T <sub>C</sub> = 25°C	75	79	—	78	80	—	%
	T <sub>C</sub> = -55°C TO +125°C	72	—	—	75	—	—	
LOAD FAULT <sup>5, 6</sup>	POWER DISSIPATION	—	3	6	—	3	6	W
SHORT CIRCUIT	RECOVERY <sup>1</sup>	—	6	30	—	6	30	ms
STEP LOAD RESPONSE <sup>6, 7, 8</sup> 50% - 100% - 50%	TRANSIENT	—	±200	±500	—	±200	±300	mV pk
	RECOVERY	—	90	400	—	90	120	μs
STEP LINE RESPONSE <sup>1, 6, 9</sup> ± 2 V STEP TRANSIENT <sup>10</sup>	TRANSIENT	—	±2	±5	—	±2	±5	%
	RECOVERY	—	100	—	—	120	—	μs
STARTUP <sup>6, 11</sup>	DELAY	—	12	25	—	10	25	ms
	OVERSHOOT	0	100	500	—	100	500	mV pk
CAPACITIVE LOAD <sup>1, 12</sup>	T <sub>C</sub> = 25°C	—	—	47	—	—	10	μF

### Notes

- Guaranteed by characterization test and/or analysis. Not a production test.
- Up to 70% of the total output power is available from either output providing the opposite output is simultaneously carrying 30% of the total output power. Each output must carry a minimum of 30% of the total output power in order to maintain regulation on the negative output.
- Balanced loads.
- Effect on -V<sub>OUT</sub> for the following conditions:  
+P<sub>O</sub> = 50%, -P<sub>O</sub> = 10%; +P<sub>O</sub> = 10%, -P<sub>O</sub> = 50%  
+P<sub>O</sub> = 70%, -P<sub>O</sub> = 30%; +P<sub>O</sub> = 30%, -P<sub>O</sub> = 70%  
All conditions are referenced to balanced loads
- Indefinite short circuit protection not guaranteed above 125°C (case)
- Recovery time is measured from application of the transient to point at which V<sub>OUT</sub> is within 1% of final value.
- Response of either output with balanced loads simultaneously transitioned from 50% to 100% to 50%.
- Step load transition test is performed at 10 microseconds typical.
- Step line characterization test is performed at 100 microseconds ± 20 microseconds.
- ± 2 V step transients from Vin 35 to 37 up to 55 and the reverse for 55 to 35.
- Tested on release from inhibit.
- Applies to each output.

# SMHF42 Single and Dual DC-DC Converters

## 35-55 VOLT INPUT – 15 WATT

TABLE 9: ELECTRICAL CHARACTERISTICS: -55°C TO +125°C CASE, 42 VIN, 100% LOAD, UNLESS OTHERWISE SPECIFIED.

DUAL OUTPUT MODELS		SMHF4212D			SMHF4215D			UNITS
PARAMETER	CONDITIONS	MIN	TYP	MAX	MIN	TYP	MAX	
OUTPUT VOLTAGE	+V <sub>OUT</sub>	11.76	12.00	12.24	14.70	15.00	15.30	V
	-V <sub>OUT</sub>	11.70	12.00	12.30	14.63	15.00	15.38	
OUTPUT CURRENT <sup>2</sup> V <sub>IN</sub> = 35 TO 55 V	EITHER OUTPUT	—	±0.625	0.875	—	±0.5	0.7	A
	TOTAL	—	—	1.25	—	—	1.0	
OUTPUT POWER <sup>2</sup> V <sub>IN</sub> = 35 TO 55 V	EITHER OUTPUT	—	—	10.5	—	—	10.5	W
	TOTAL	—	—	15	—	—	15	
OUTPUT RIPPLE ± V <sub>OUT</sub> 10 kHz - 2 MHz	T <sub>C</sub> = 25°C	—	30	95	—	30	95	mV p-p
	T <sub>C</sub> = -55°C TO +125°C	—	30	95	—	30	95	
OUTPUT RIPPLE ± V <sub>OUT</sub> 10 kHz - 10 MHz	T <sub>C</sub> = 25°C	—	30	110	—	30	110	mV p-p
	T <sub>C</sub> = -55°C TO +125°C	—	30	110	—	30	110	
LINE REGULATION <sup>3</sup> V <sub>IN</sub> = 35 TO 55 V	+V <sub>OUT</sub>	—	2	30	—	2	30	mV
	-V <sub>OUT</sub>	—	10	100	—	10	100	
LOAD REGULATION <sup>3</sup> NO LOAD TO FULL	+V <sub>OUT</sub>	—	5	35	—	5	35	mV
	-V <sub>OUT</sub>	—	60	150	—	40	150	
CROSS REGULATION <sup>4</sup>	EFFECT ON -V <sub>OUT</sub>	—	—	720	—	—	900	mV
INPUT VOLTAGE NO LOAD TO FULL	CONTINUOUS	35	42	55	35	42	55	V
	TRANSIENT 50 ms <sup>1</sup>	—	—	80	—	—	80	V
INPUT CURRENT	NO LOAD	—	30	50	—	30	50	mA
	INHIBITED	—	6	10	—	6	10	
INPUT RIPPLE CURRENT	10 kHz - 10 MHz	—	55	120	—	55	120	mA p-p
EFFICIENCY	T <sub>C</sub> = 25°C	76	80	—	76	82	—	%
	T <sub>C</sub> = -55°C TO +125°C	74	—	—	74	—	—	
LOAD FAULT <sup>5, 6</sup>	POWER DISSIPATION	—	3	6	—	3	6	W
SHORT CIRCUIT	RECOVERY <sup>1</sup>	—	6	50	—	6	50	ms
STEP LOAD RESPONSE <sup>6, 7, 8</sup> 50% - 100% - 50%	TRANSIENT	—	±300	±600	—	±300	±600	mV pk
	RECOVERY	—	90	400	—	90	400	μs
STEP LINE RESPONSE <sup>1, 6, 9</sup> ± 2 V STEP TRANSIENT <sup>10</sup>	TRANSIENT	—	±2	±5	—	±2	±5	%
	RECOVERY	—	150	—	—	150	—	μs
STARTUP <sup>6, 11</sup>	DELAY	—	10	20	—	10	20	ms
	OVERSHOOT	0	100	500	0	100	500	mV pk
CAPACITIVE LOAD <sup>1, 12</sup>	T <sub>C</sub> = 25°C	—	—	10	—	—	10	μF

## Notes

- Guaranteed by characterization test and/or analysis. Not a production test.
- Up to 70% of the total output power is available from either output providing the opposite output is simultaneously carrying 30% of the total output power. Each output must carry a minimum of 30% of the total output power in order to maintain regulation on the negative output.
- Balanced loads.
- Effect on -V<sub>OUT</sub> for the following conditions:  
+P<sub>O</sub> = 50%, -P<sub>O</sub> = 10%; +P<sub>O</sub> = 10%, -P<sub>O</sub> = 50%  
+P<sub>O</sub> = 70%, -P<sub>O</sub> = 30%; +P<sub>O</sub> = 30%, -P<sub>O</sub> = 70%  
All conditions are referenced to balanced loads.
- Indefinite short circuit protection not guaranteed above 125°C (case)
- Recovery time is measured from application of the transient to point at which V<sub>OUT</sub> is within 1% of final value.
- Response of either output with balanced loads simultaneously transitioned from 50% to 100% to 50%.
- Step load transition test is performed at 10 microseconds typical.
- Step line characterization test is performed at 100 microseconds ± 20 microseconds.
- ± 2 V step transients from Vin 35 to 37 up to 55 and the reverse for 55 to 35.
- Tested on release from inhibit.
- Applies to each output.

# SMHF42 Single and Dual DC-DC Converters

## 35-55 VOLT INPUT – 15 WATT

TYPICAL PERFORMANCE PLOTS: 25°C CASE, 42 V<sub>IN</sub>, 100% LOAD, UNLESS OTHERWISE SPECIFIED.  
FOR REFERENCE ONLY. NOT GUARANTEED SPECIFICATIONS.

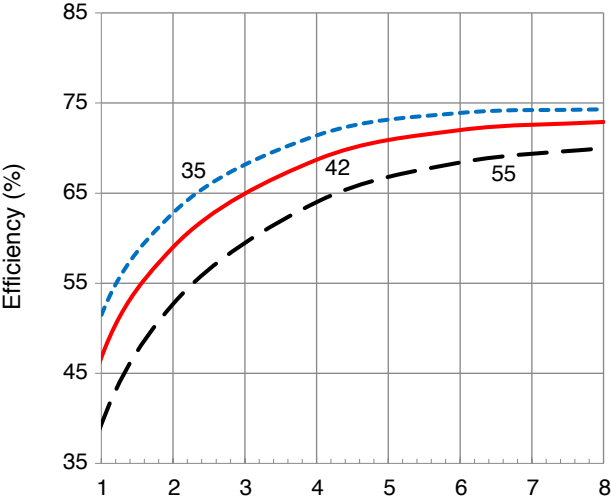

Output Power (Watts)  
SMHF423R3S EFFICIENCY

FIGURE 5

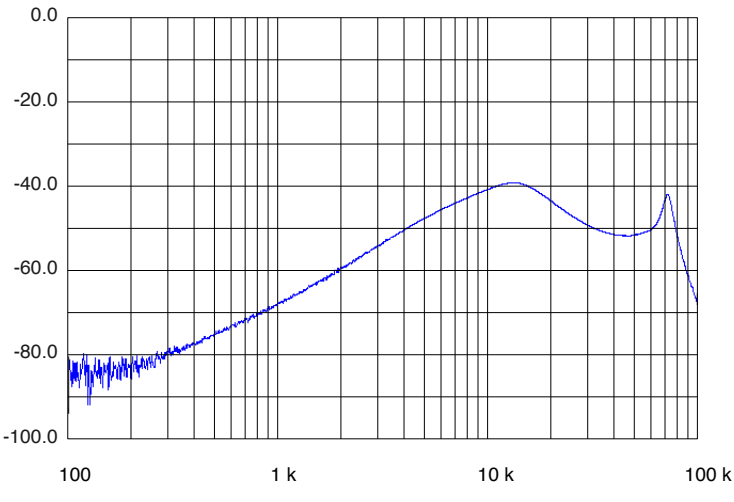

Frequency (Hz), 42 V<sub>IN</sub>  
SMHF423R3S AUDIO REJECTION

FIGURE 6

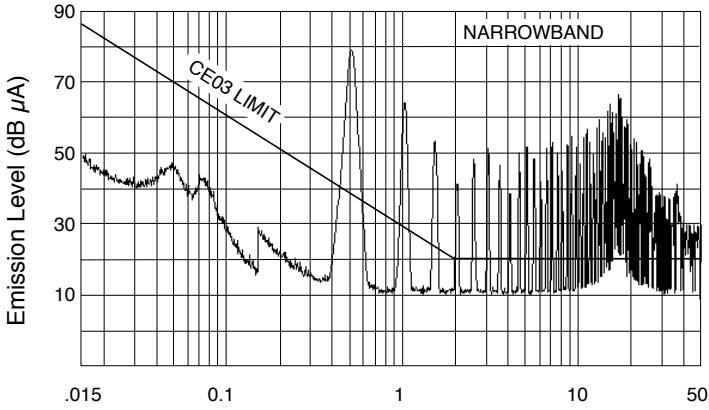

Frequency (MHz), 42 V<sub>IN</sub> Unfiltered  
SMHF423R3S MIL-STD-461C, CE03

FIGURE 7

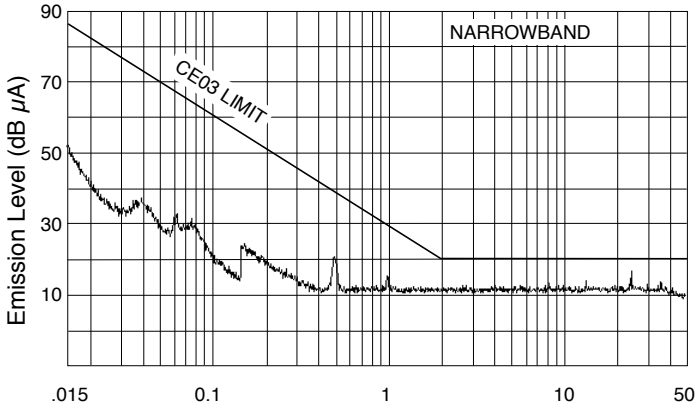

Frequency (MHz), 42 V<sub>IN</sub> with SFMC28-461 EMI Filter  
SMHF423R3S MIL-STD-461C, CE03

FIGURE 8

# SMHF42 Single and Dual DC-DC Converters

## 35-55 VOLT INPUT – 15 WATT

TYPICAL PERFORMANCE PLOTS: 25°C CASE, 42 V<sub>IN</sub>, 100% LOAD, UNLESS OTHERWISE SPECIFIED.  
FOR REFERENCE ONLY. NOT GUARANTEED SPECIFICATIONS.

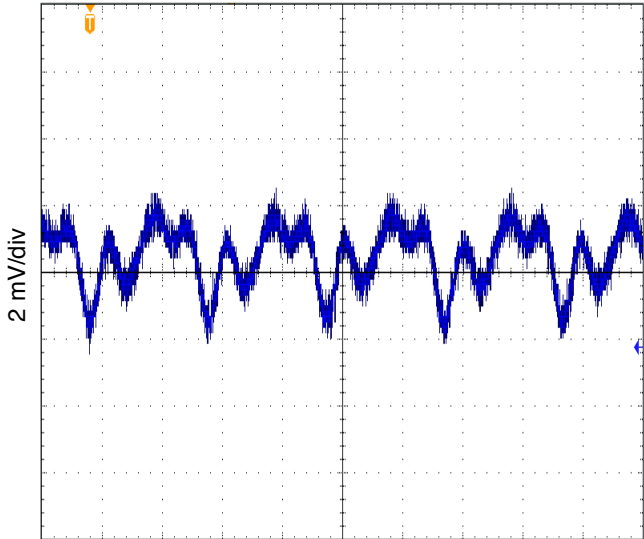

1  $\mu$ s/div  
SMHF423R3S OUTPUT RIPPLE 2 MHz  
FIGURE 9

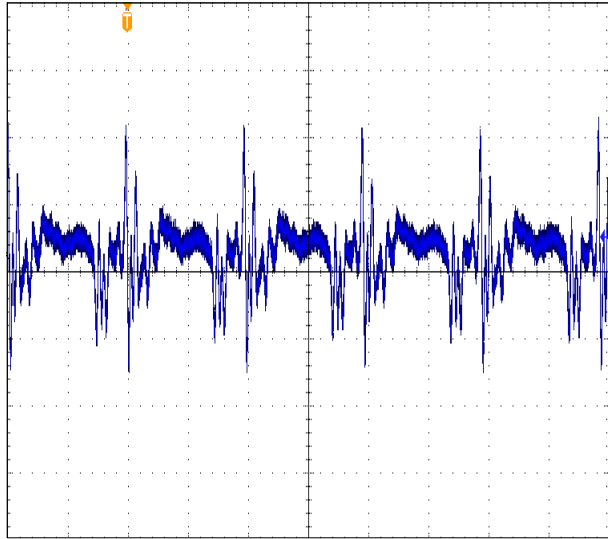

1  $\mu$ s/div  
SMHF423R3S OUTPUT RIPPLE 10 MHz  
FIGURE 10

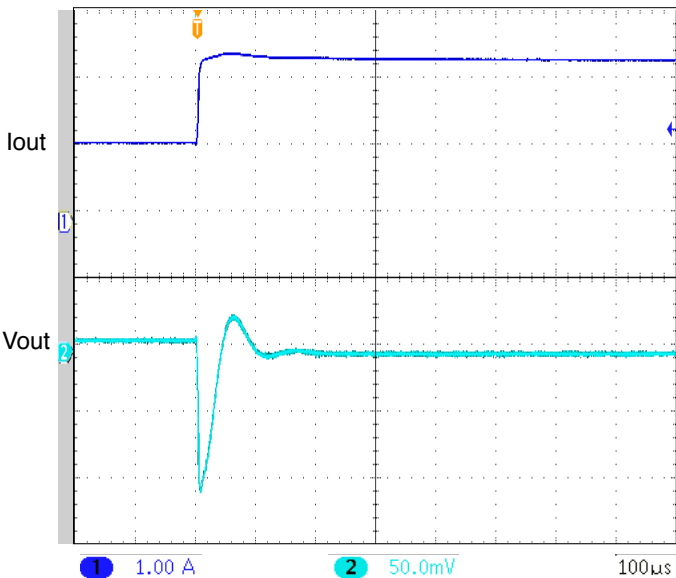

UNITS ARE PER DIVISION  
SMHF423R3S STEP LOAD 50% - 100%  
FIGURE 11

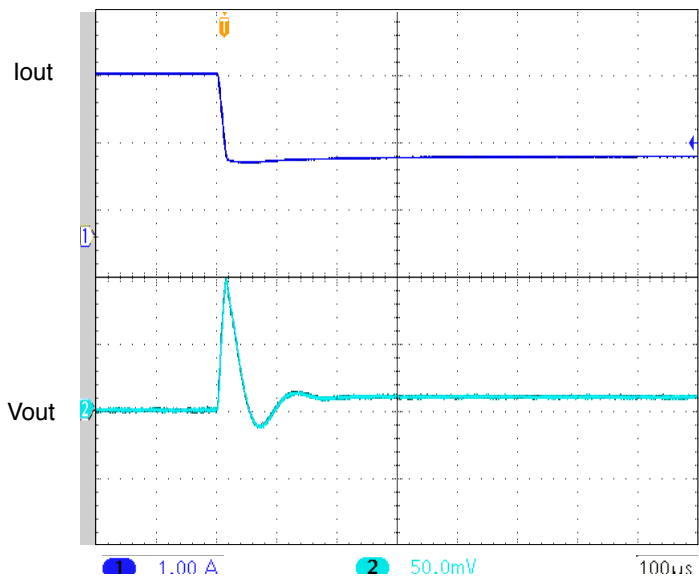

UNITS ARE PER DIVISION  
SMHF423R3S STEP LOAD 100% - 50%  
FIGURE 12

# SMHF42 Single and Dual DC-DC Converters

## 35-55 VOLT INPUT – 15 WATT

TYPICAL PERFORMANCE PLOTS: 25°C CASE, 42 V<sub>IN</sub>, 100% LOAD, UNLESS OTHERWISE SPECIFIED.  
FOR REFERENCE ONLY. NOT GUARANTEED SPECIFICATIONS.

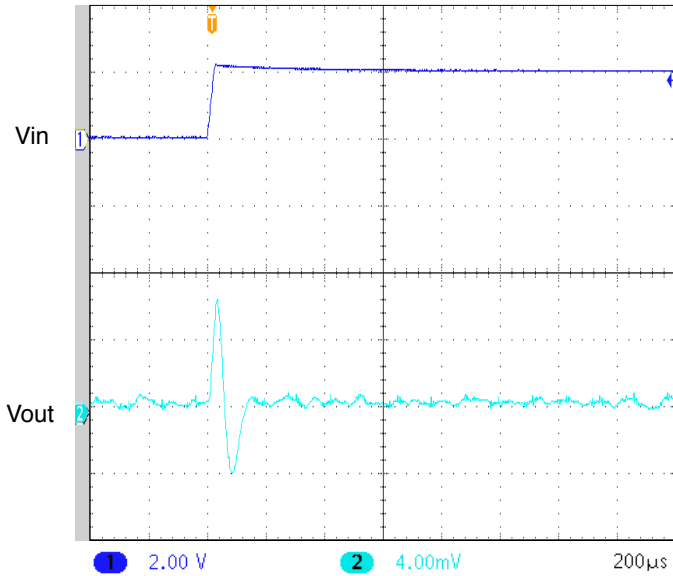

UNITS ARE PER DIVISION  
SMHF423R3S STEP LINE 41 - 43 VOLTS IN  
FIGURE 13

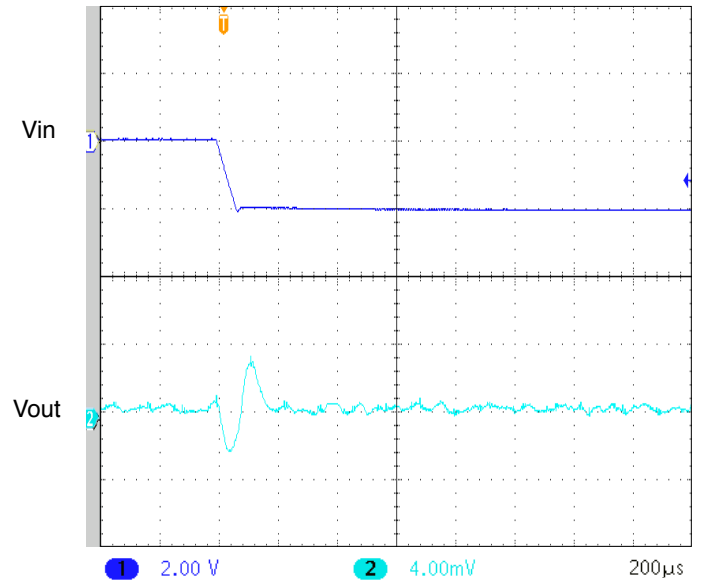

UNITS ARE PER DIVISION  
SMHF423R3S STEP LINE 43 - 41 VOLTS IN  
FIGURE 14

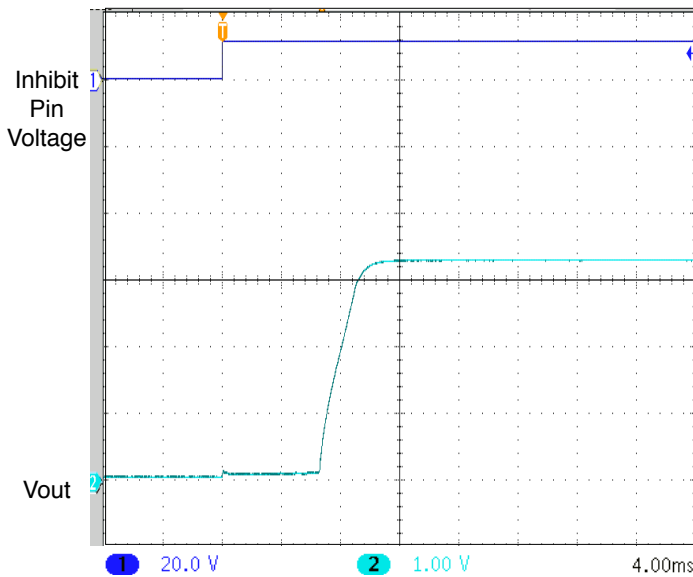

UNITS ARE PER DIVISION  
SMHF423R3S START-UP DELAY NO CAP  
FIGURE 15

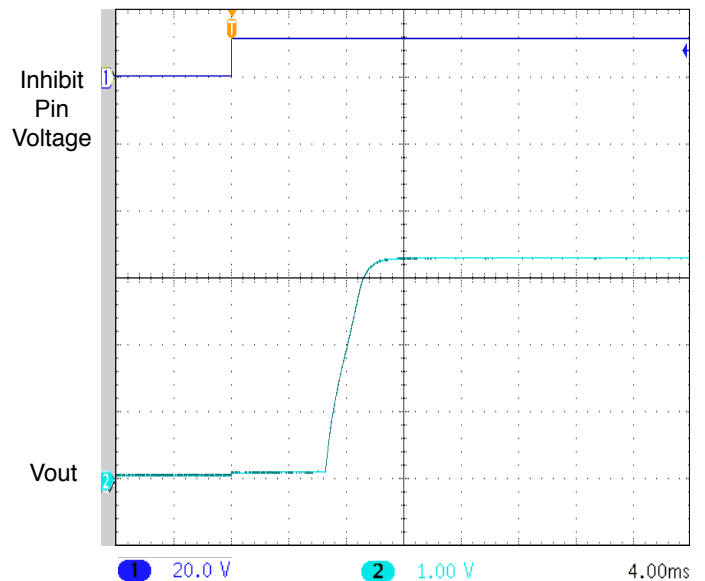

UNITS ARE PER DIVISION  
SMHF423R3S START-UP DELAY WITH 300 µF CAP  
FIGURE 16

# SMHF42 Single and Dual DC-DC Converters

## 35-55 VOLT INPUT – 15 WATT

TYPICAL PERFORMANCE PLOTS: 25°C CASE, 42 V<sub>IN</sub>, 100% LOAD, UNLESS OTHERWISE SPECIFIED.  
FOR REFERENCE ONLY. NOT GUARANTEED SPECIFICATIONS.

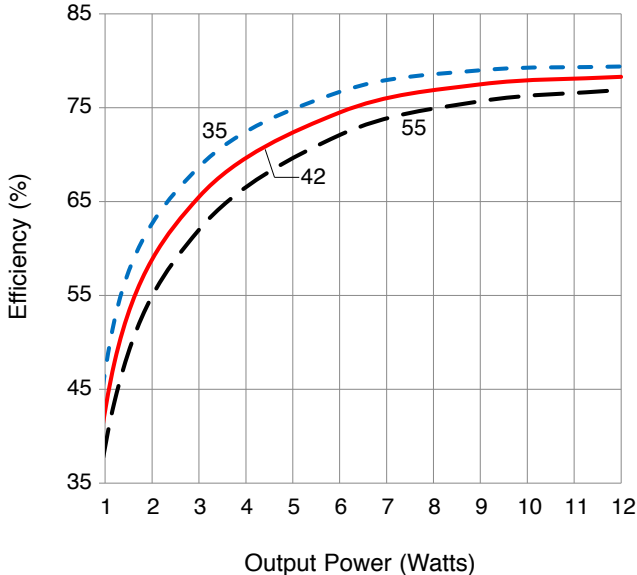

Output Power (Watts)  
SMHF4205S EFFICIENCY  
FIGURE 17

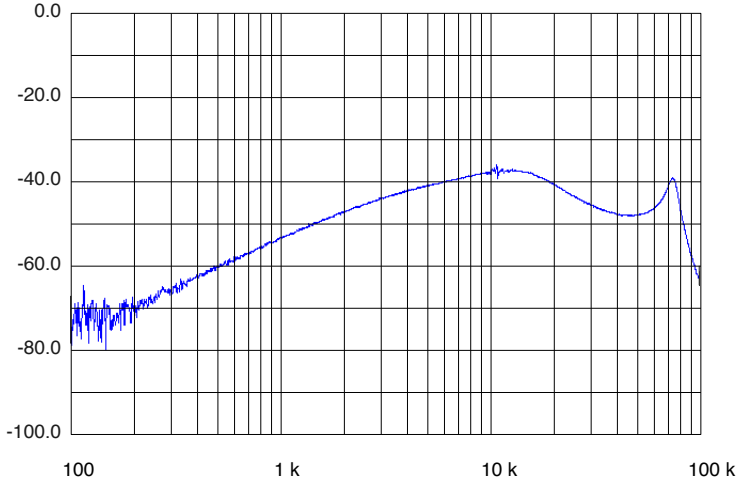

Frequency (Hz), 42 V<sub>IN</sub>  
SMHF4205S AUDIO REJECTION  
FIGURE 18

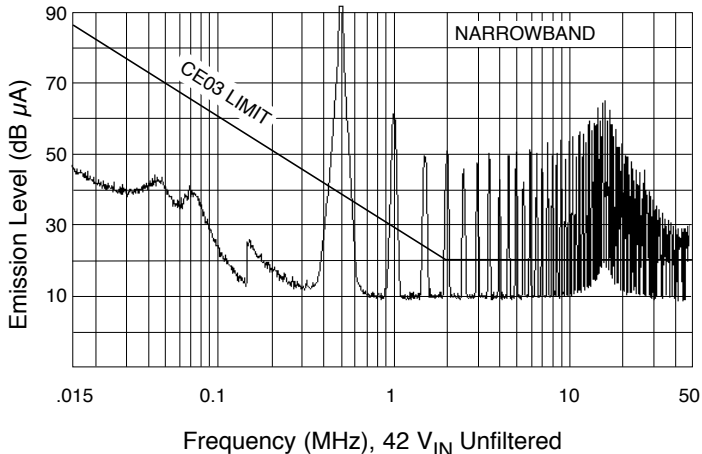

Frequency (MHz), 42 V<sub>IN</sub> Unfiltered  
SMHF4205S MIL-STD-461C, CE03

FIGURE 19

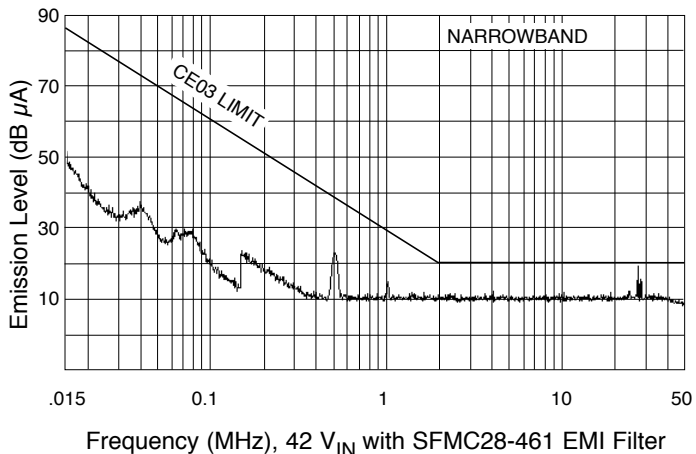

Frequency (MHz), 42 V<sub>IN</sub> with SFMC28-461 EMI Filter  
SMHF4205S MIL-STD-461C, CE03

FIGURE 20

# SMHF42 Single and Dual DC-DC Converters

## 35-55 VOLT INPUT – 15 WATT

TYPICAL PERFORMANCE PLOTS: 25°C CASE, 42 V<sub>IN</sub>, 100% LOAD, UNLESS OTHERWISE SPECIFIED.  
FOR REFERENCE ONLY. NOT GUARANTEED SPECIFICATIONS.

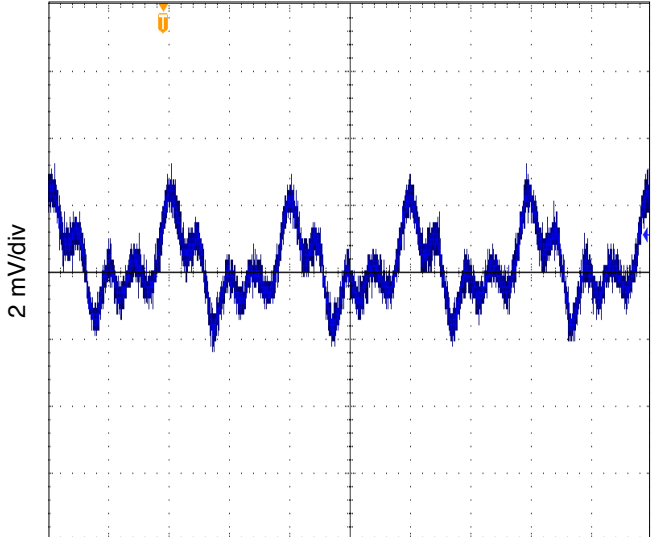

1 μs/div  
SMHF4205S OUTPUT RIPPLE 2 MHZ  
FIGURE 21

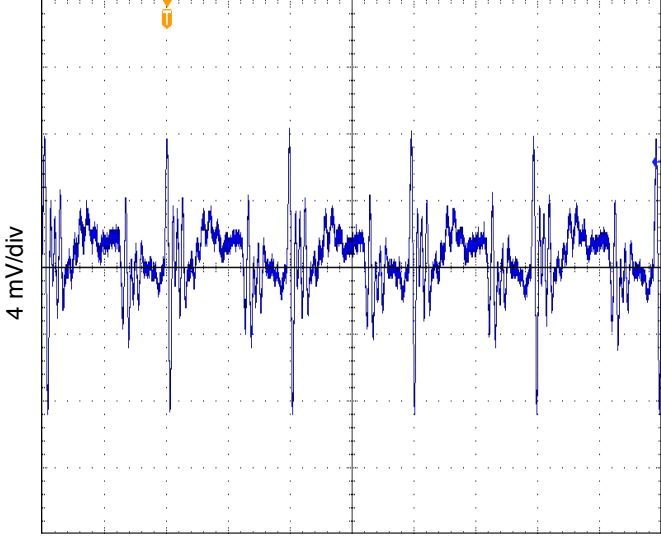

1 μs/div  
SMHF4205S OUTPUT RIPPLE 10 MHZ  
FIGURE 22

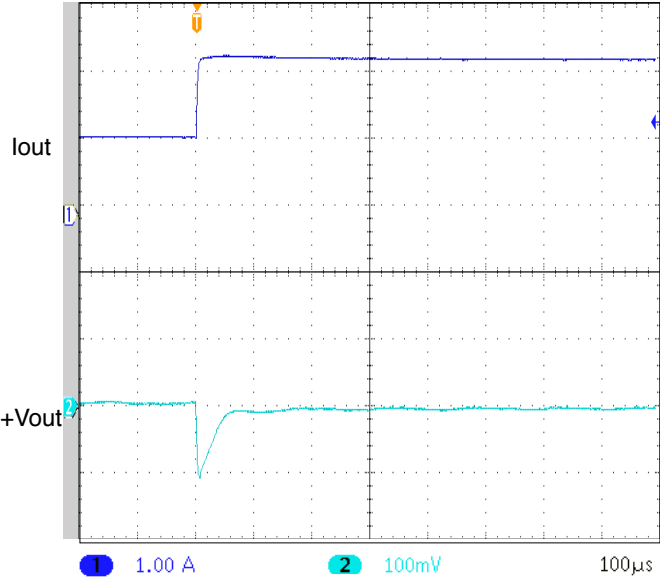

UNITS ARE PER DIVISION  
SMHF4205S STEP LOAD 50% - 100%  
FIGURE 23

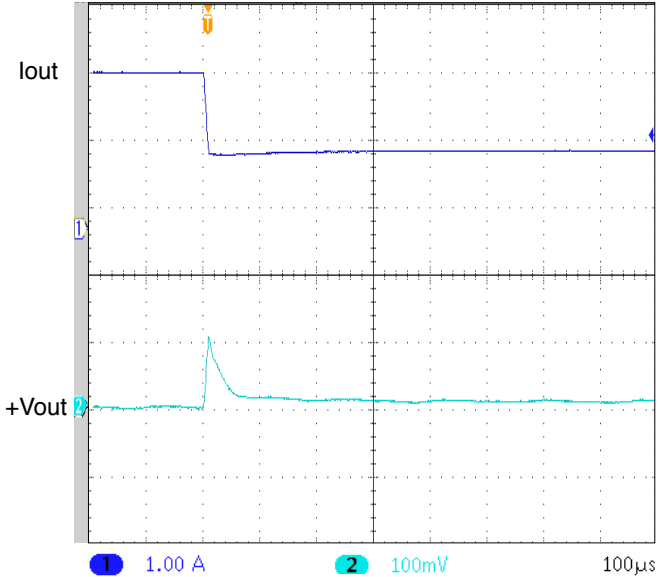

UNITS ARE PER DIVISION  
SMHF4205S STEP LOAD 100% - 50%  
FIGURE 24

# SMHF42 Single and Dual DC-DC Converters

## 35-55 VOLT INPUT – 15 WATT

TYPICAL PERFORMANCE PLOTS: 25°C CASE, 42 V<sub>IN</sub>, 100% LOAD, UNLESS OTHERWISE SPECIFIED.  
FOR REFERENCE ONLY. NOT GUARANTEED SPECIFICATIONS.

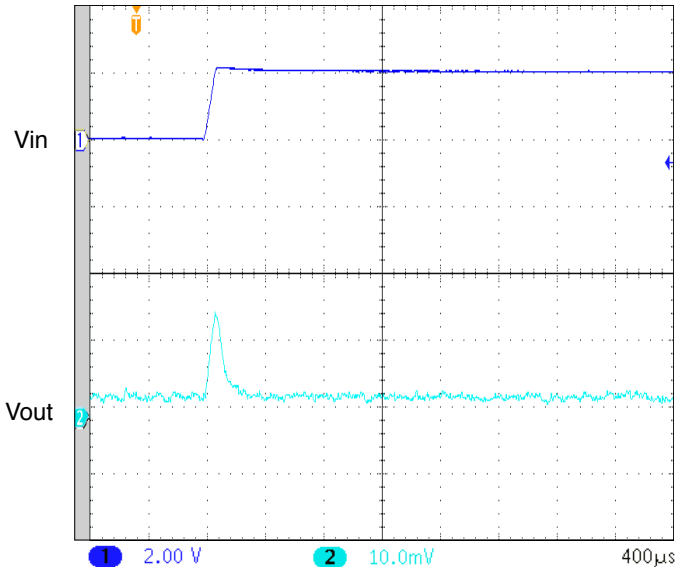

UNITS ARE PER DIVISION  
SMHF4205S STEP LINE 41 - 43 VOLTS IN  
FIGURE 25

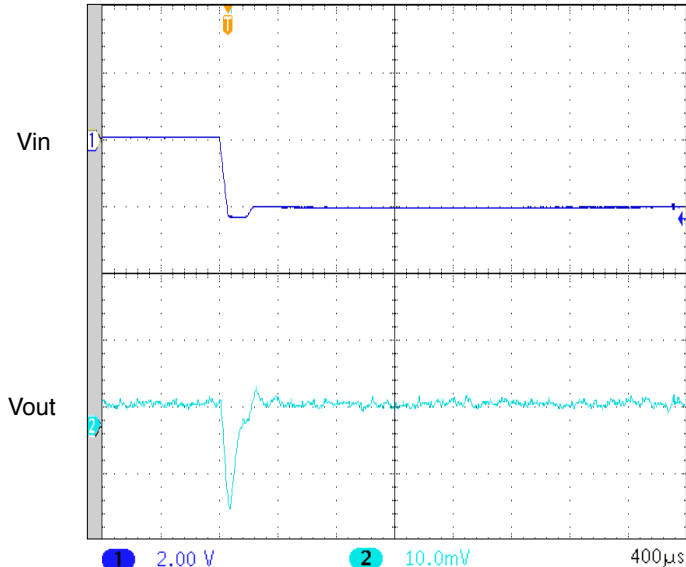

UNITS ARE PER DIVISION  
SMHF4205S STEP LINE 43 - 41 VOLTS IN  
FIGURE 26

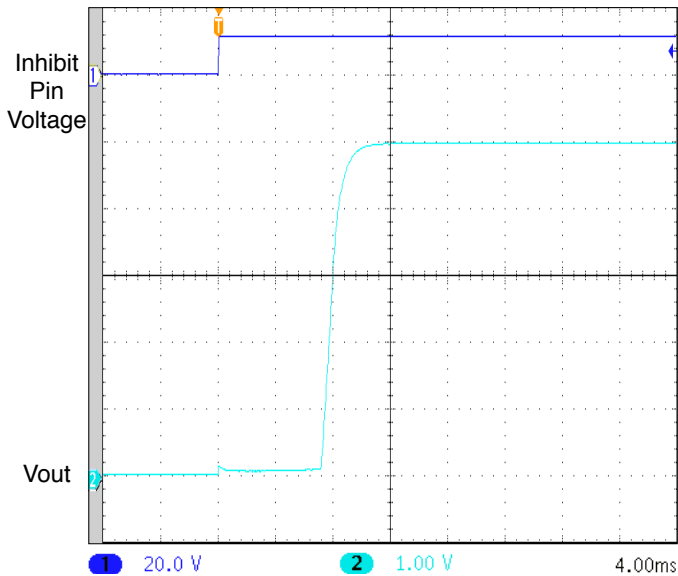

UNITS ARE PER DIVISION  
SMHF4205S START-UP DELAY NO CAP  
FIGURE 27

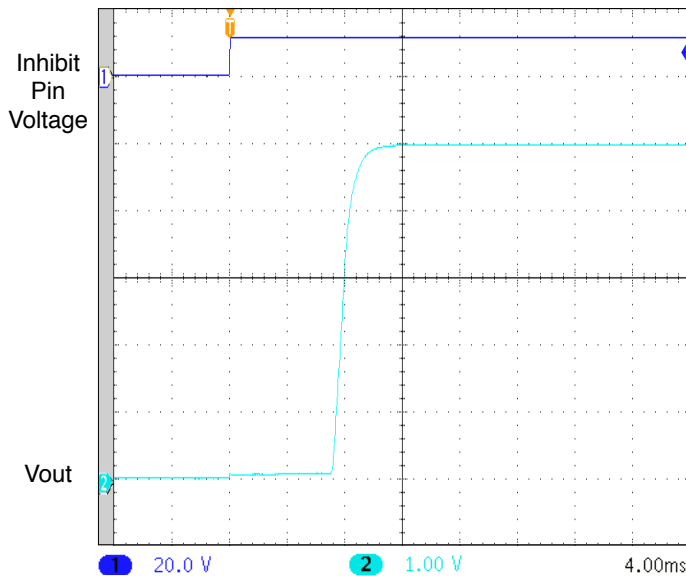

UNITS ARE PER DIVISION  
SMHF4205S START-UP DELAY WITH 300 μF CAP  
FIGURE 28



# SMHF42 Single and Dual DC-DC Converters

## 35-55 VOLT INPUT – 15 WATT

TYPICAL PERFORMANCE PLOTS: 25°C CASE, 42 V<sub>IN</sub>, 100% LOAD, UNLESS OTHERWISE SPECIFIED.  
FOR REFERENCE ONLY. NOT GUARANTEED SPECIFICATIONS.

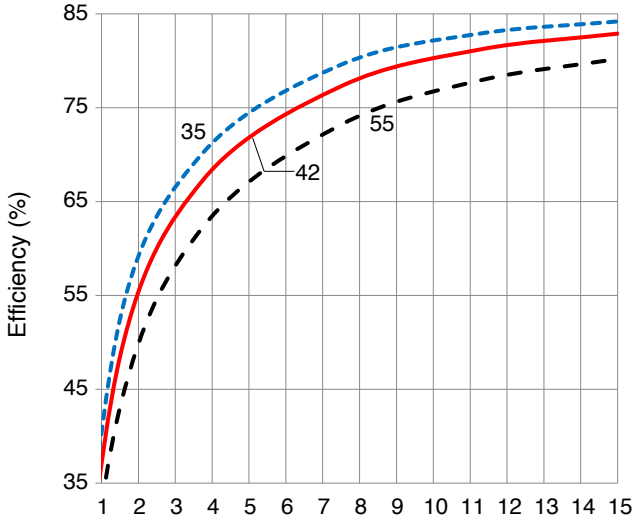

Output Power (Watts)  
SMHF4215S EFFICIENCY  
FIGURE 29

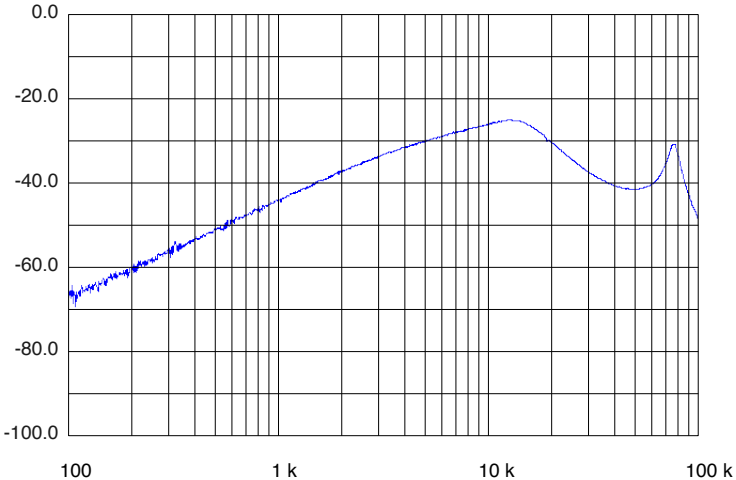

Frequency (Hz), 42 V<sub>IN</sub>  
SMHF4215S AUDIO REJECTION  
FIGURE 30

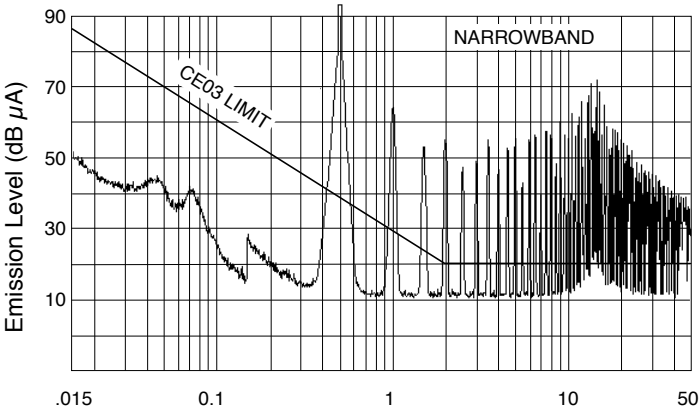

Frequency (MHz), 42 V<sub>IN</sub> Unfiltered  
SMHF4215S MIL-STD-461C, CE03  
FIGURE 31

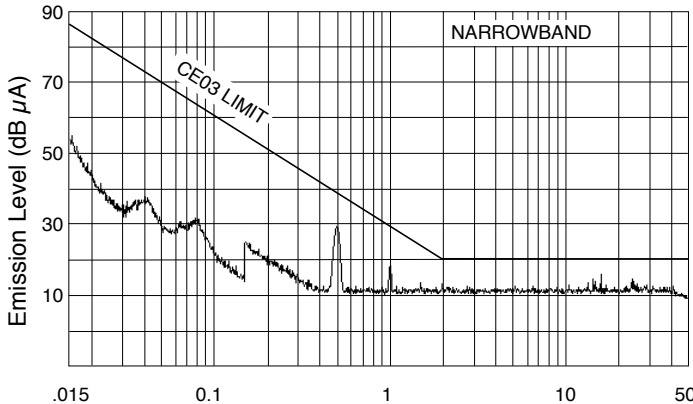

Frequency (MHz), 42 V<sub>IN</sub> with SFMC28-461 EMI Filter  
SMHF4215S MIL-STD-461C, CE03  
FIGURE 32

# SMHF42 Single and Dual DC-DC Converters

## 35-55 VOLT INPUT – 15 WATT

TYPICAL PERFORMANCE PLOTS: 25°C CASE, 42 V<sub>IN</sub>, 100% LOAD, UNLESS OTHERWISE SPECIFIED.  
FOR REFERENCE ONLY. NOT GUARANTEED SPECIFICATIONS.

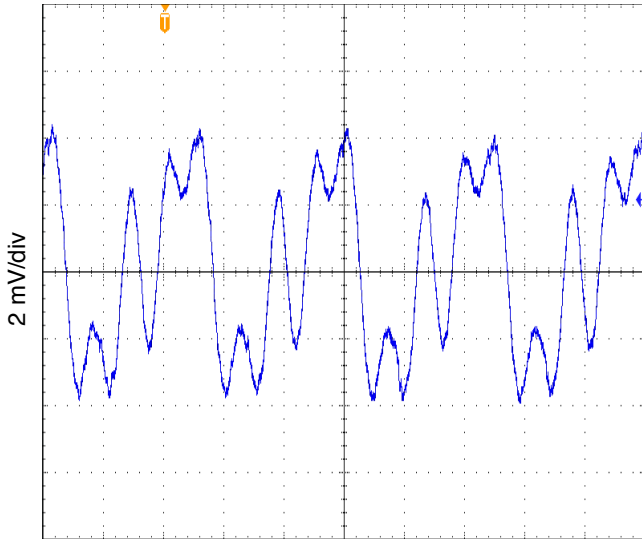

800 nanoseconds/div  
SMHF4215S OUTPUT RIPPLE 2 MHZ  
FIGURE 33

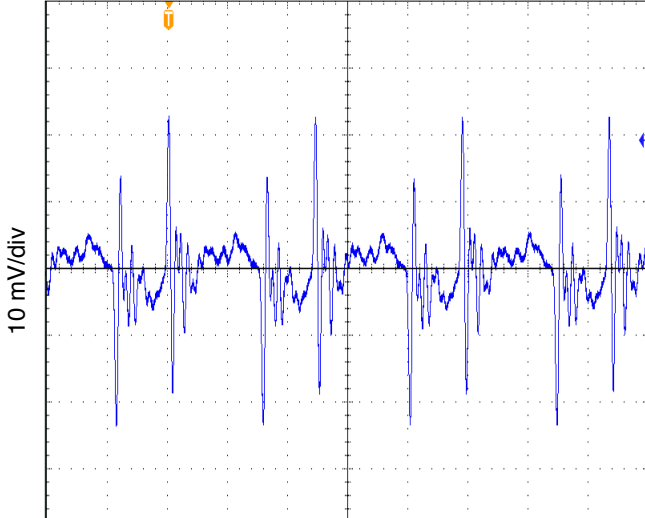

800 nanoseconds/div  
SMHF4215S OUTPUT RIPPLE 10 MHZ  
FIGURE 34

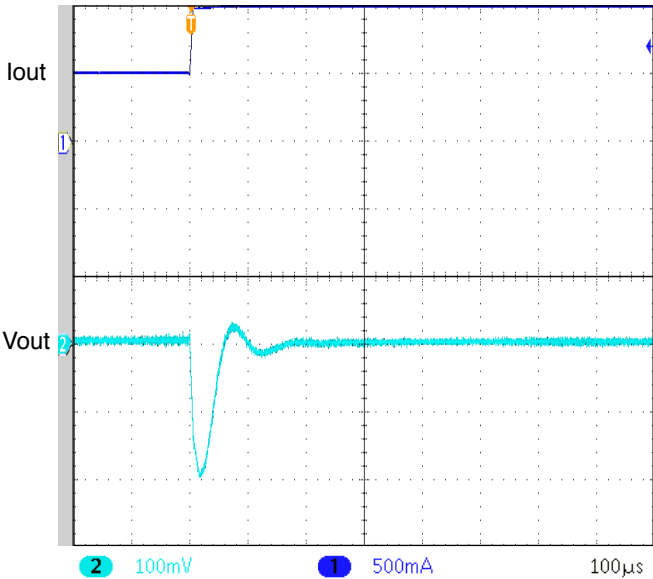

UNITS ARE PER DIVISION  
SMHF4215S STEP LOAD 50% - 100%  
FIGURE 35

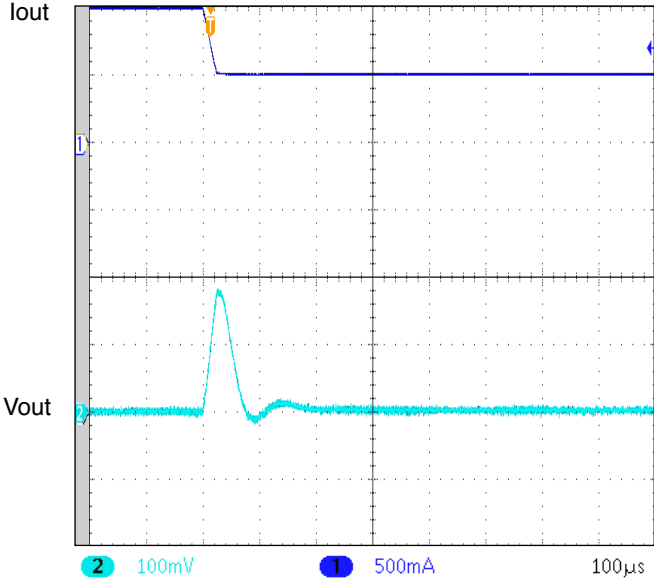

UNITS ARE PER DIVISION  
SMHF4215S STEP LOAD 100% - 50%  
FIGURE 36

# SMHF42 Single and Dual DC-DC Converters

## 35-55 VOLT INPUT – 15 WATT

TYPICAL PERFORMANCE PLOTS: 25°C CASE, 42 V<sub>IN</sub>, 100% LOAD, UNLESS OTHERWISE SPECIFIED.  
FOR REFERENCE ONLY. NOT GUARANTEED SPECIFICATIONS.

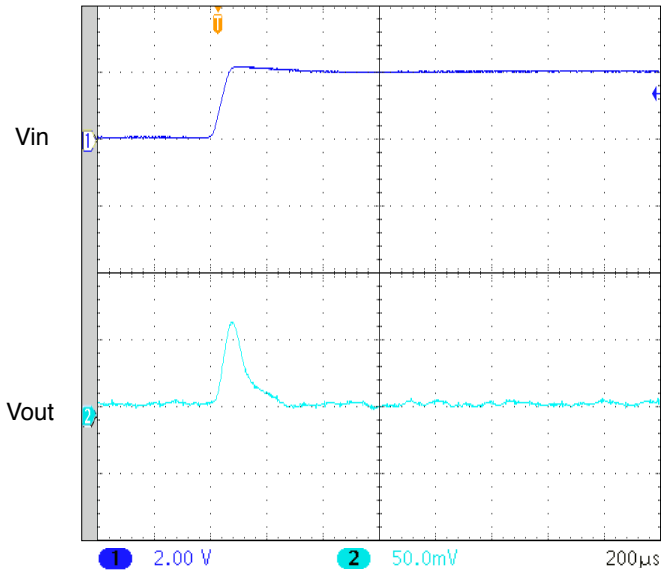

UNITS ARE PER DIVISION  
SMHF4215S STEP LINE 41 - 43 VOLTS IN  
FIGURE 37

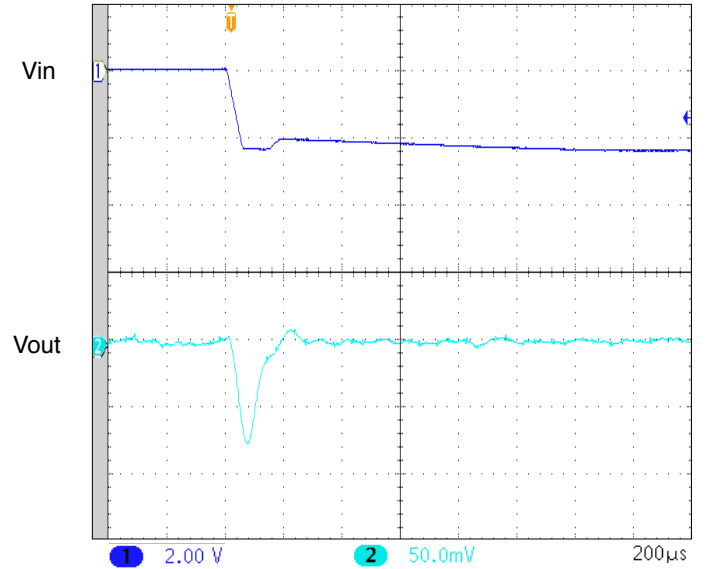

UNITS ARE PER DIVISION  
SMHF4215S STEP LINE 43 - 41 VOLTS IN  
FIGURE 38

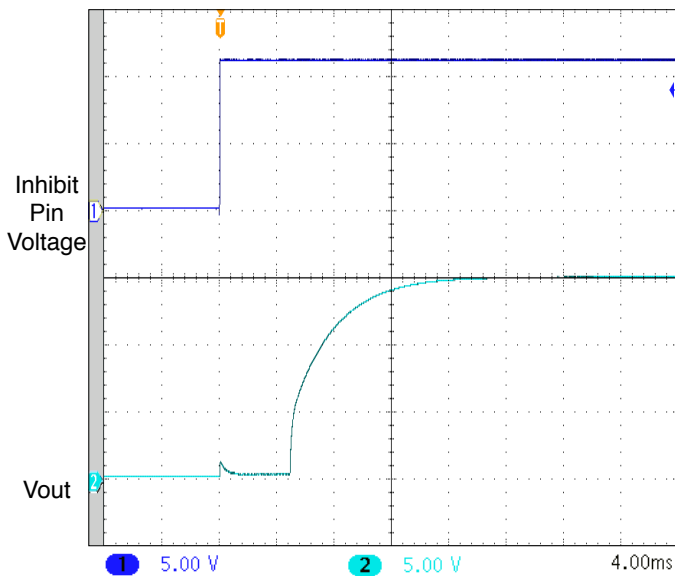

UNITS ARE PER DIVISION  
SMHF4215S START-UP DELAY NO CAP  
FIGURE 39

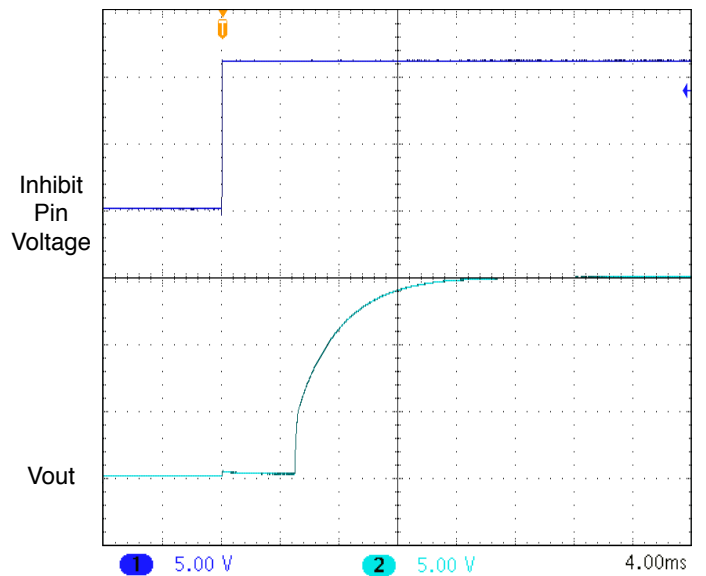

UNITS ARE PER DIVISION  
SMHF4215S START-UP DELAY WITH 100 µF CAP  
FIGURE 40

# SMHF42 Single and Dual DC-DC Converters

## 35-55 VOLT INPUT – 15 WATT

TYPICAL PERFORMANCE PLOTS: 25°C CASE, 42 V<sub>IN</sub>, 100% LOAD, UNLESS OTHERWISE SPECIFIED.  
FOR REFERENCE ONLY. NOT GUARANTEED SPECIFICATIONS.

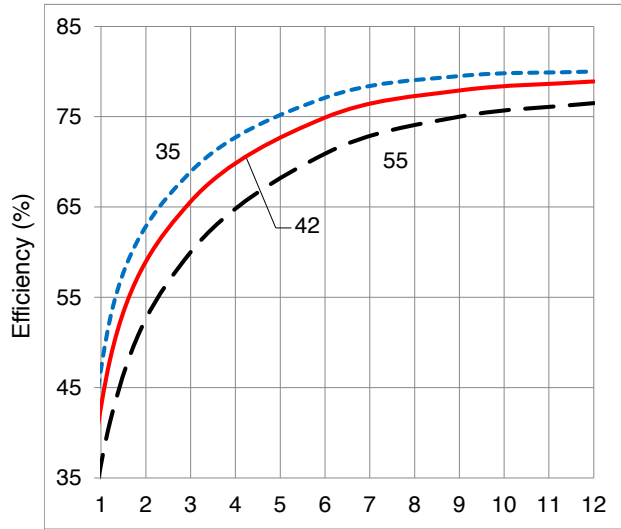

Output Power (Watts)  
SMHF4205D EFFICIENCY  
FIGURE 41

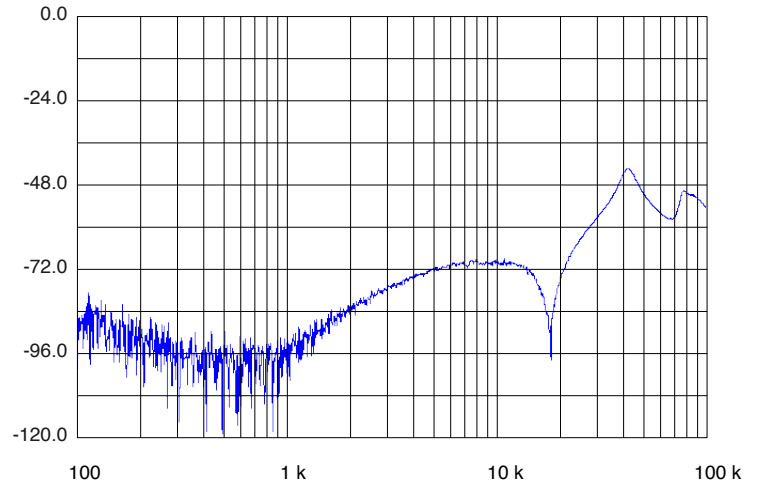

Frequency (Hz), 42 V<sub>IN</sub>  
SMHF4205D AUDIO REJECTION  
FIGURE 42

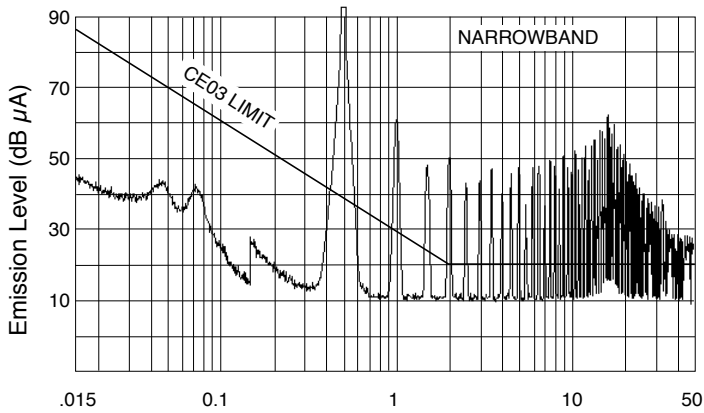

Frequency (MHz), 42 V<sub>IN</sub> Unfiltered  
SMHF4205D MIL-STD-461C, CE03  
FIGURE 43

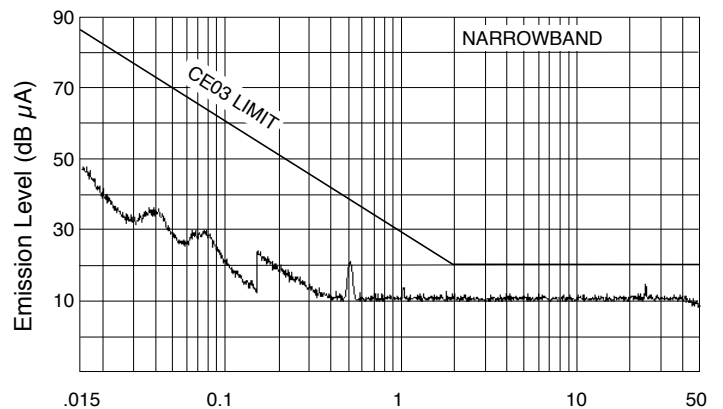

Frequency (MHz), 42 V<sub>IN</sub> with SFMC28-461 EMI Filter  
SMHF4205D MIL-STD-461C, CE03  
FIGURE 44

# SMHF42 Single and Dual DC-DC Converters

## 35-55 VOLT INPUT – 15 WATT

TYPICAL PERFORMANCE PLOTS: 25°C CASE, 42 V<sub>IN</sub>, 100% LOAD, UNLESS OTHERWISE SPECIFIED.  
FOR REFERENCE ONLY. NOT GUARANTEED SPECIFICATIONS.

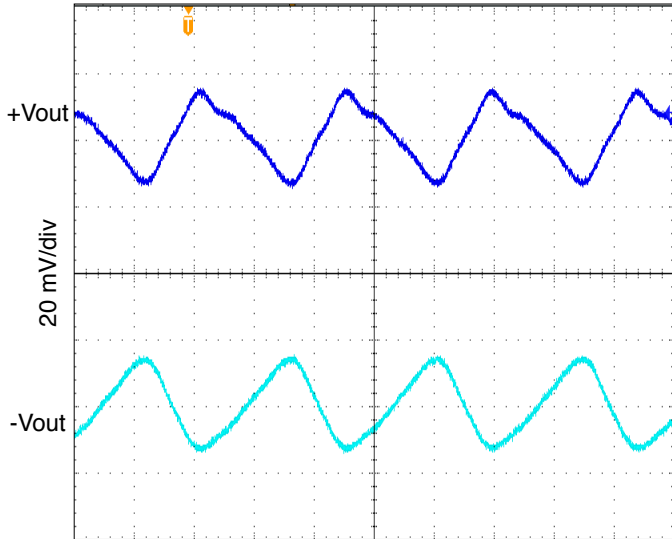

800 nanoseconds/div  
SMHF4205D OUTPUT RIPPLE 2 MHZ  
FIGURE 45

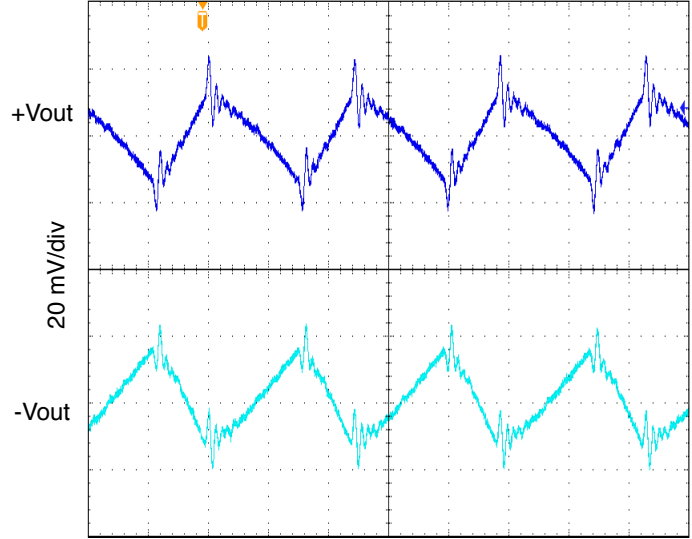

800 nanoseconds/div  
SMHF4205D OUTPUT RIPPLE 10 MHZ  
FIGURE 46

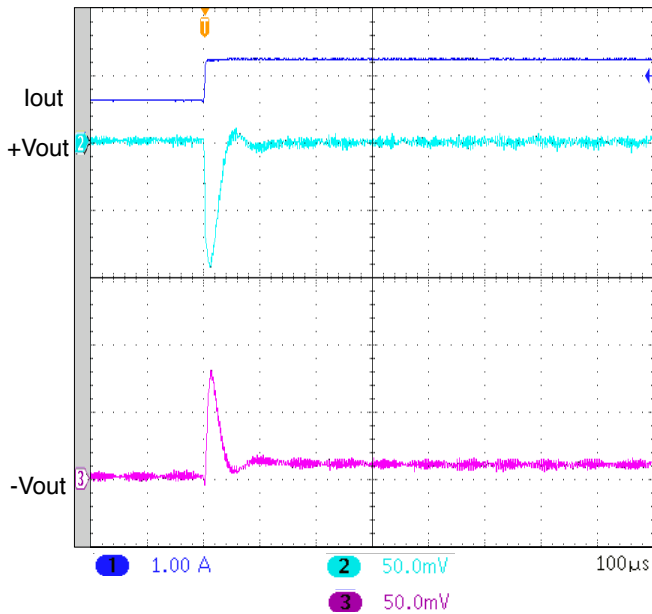

UNITS ARE PER DIVISION  
SMHF4205D STEP LOAD 50% - 100%  
FIGURE 47

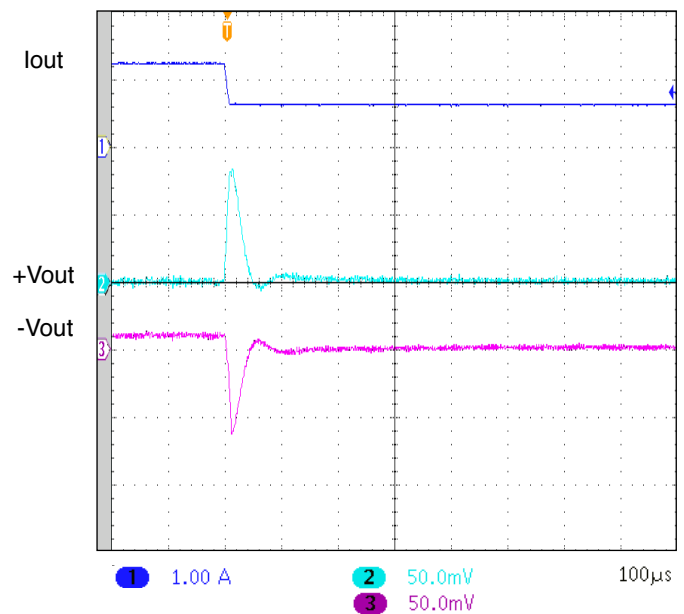

UNITS ARE PER DIVISION  
SMHF4205D STEP LOAD 100% - 50%  
FIGURE 48

# SMHF42 Single and Dual DC-DC Converters

## 35-55 VOLT INPUT – 15 WATT

TYPICAL PERFORMANCE PLOTS: 25°C CASE, 42 V<sub>IN</sub>, 100% LOAD, UNLESS OTHERWISE SPECIFIED.  
FOR REFERENCE ONLY. NOT GUARANTEED SPECIFICATIONS.

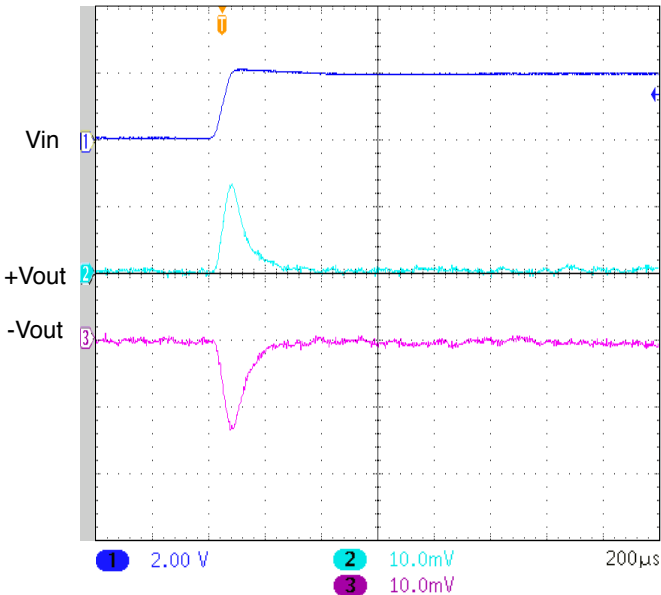

UNITS ARE PER DIVISION  
SMHF4205D STEP LINE 41 - 43 VOLTS IN  
FIGURE 49

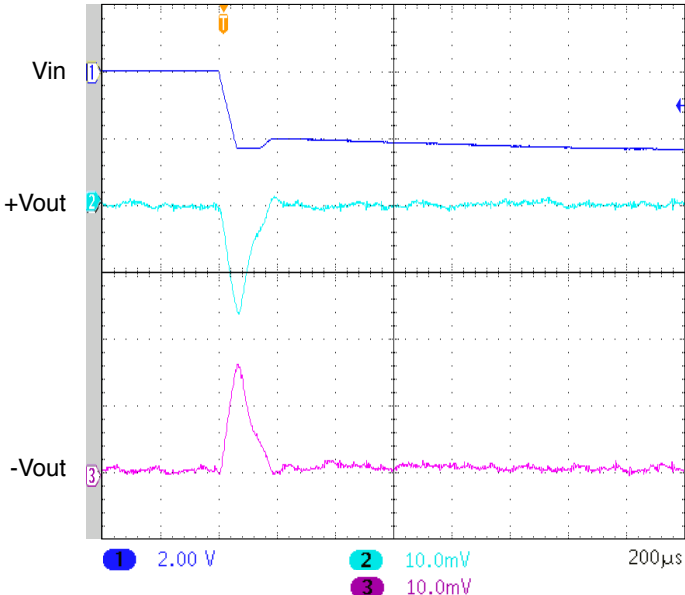

UNITS ARE PER DIVISION  
SMHF4205D STEP LINE 43 - 41 VOLTS IN  
FIGURE 50

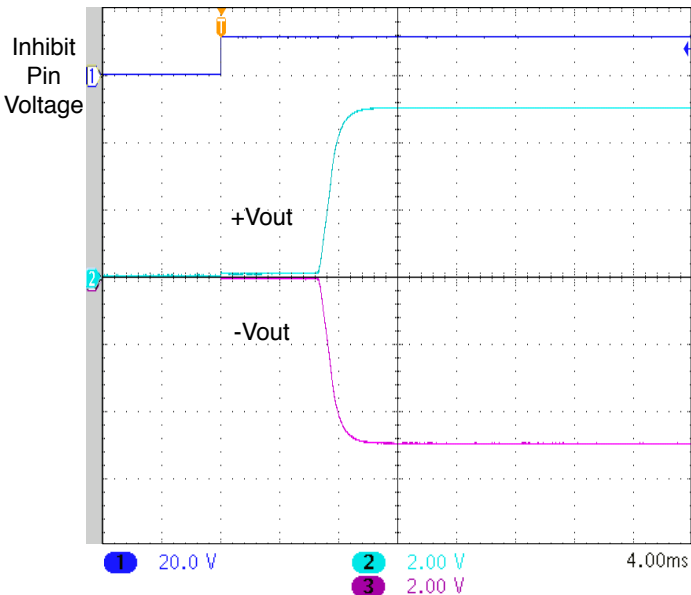

UNITS ARE PER DIVISION  
SMHF4205D START-UP DELAY NO CAP  
FIGURE 51

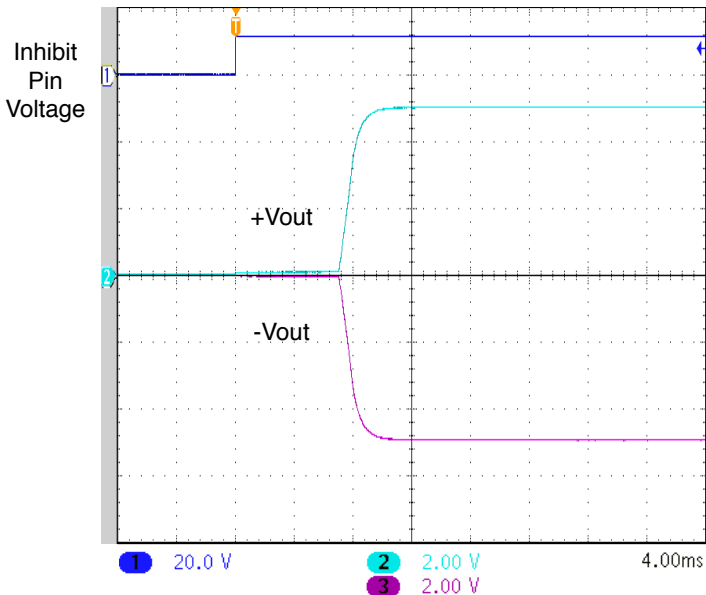

UNITS ARE PER DIVISION  
SMHF4205D START-UP DELAY WITH 100 µF CAP  
FIGURE 52

# SMHF42 Single and Dual DC-DC Converters

## 35-55 VOLT INPUT – 15 WATT

TYPICAL PERFORMANCE PLOTS: 25°C CASE, 42 V<sub>IN</sub>, 100% LOAD, UNLESS OTHERWISE SPECIFIED.  
FOR REFERENCE ONLY. NOT GUARANTEED SPECIFICATIONS.

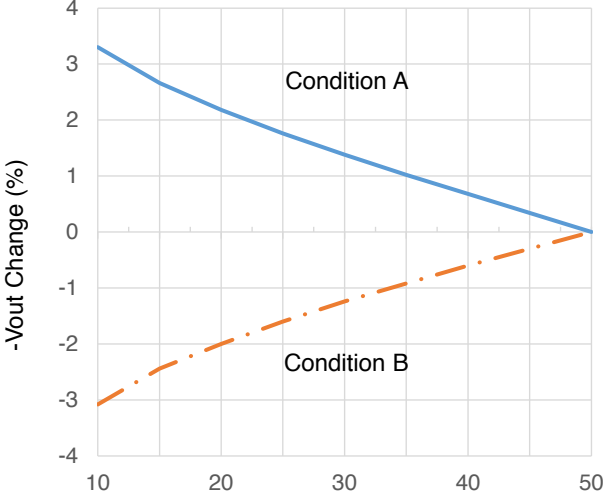

Output Power (%)  
SMHF4205D EFFICIENCY  
FIGURE 53

Condition A:  
+Vout held at 50% load.  
-Vout 10 - 50% load sweep

Condition B:  
-Vout held at 50% load.  
+Vout 10-50% load sweep

# SMHF42 Single and Dual DC-DC Converters

## 35-55 VOLT INPUT – 15 WATT

TYPICAL PERFORMANCE PLOTS: 25°C CASE, 42 V<sub>IN</sub>, 100% LOAD, UNLESS OTHERWISE SPECIFIED.  
FOR REFERENCE ONLY. NOT GUARANTEED SPECIFICATIONS.

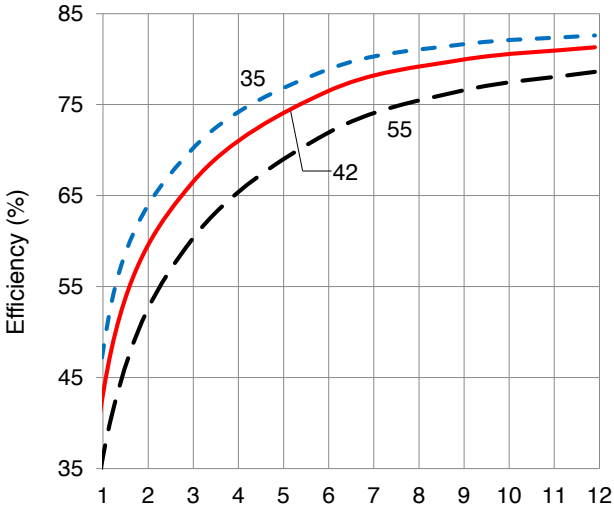

Output Power (Watts)  
SMHF4207D EFFICIENCY

FIGURE 54

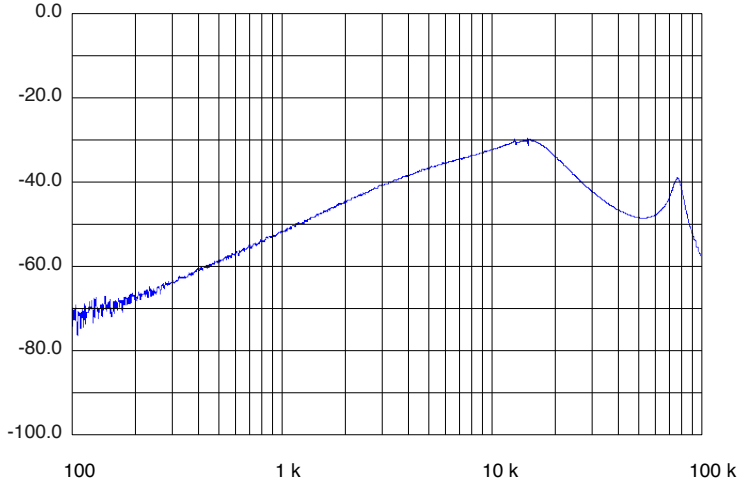

Frequency (Hz), 42 V<sub>IN</sub>  
SMHF4207D AUDIO REJECTION

FIGURE 55

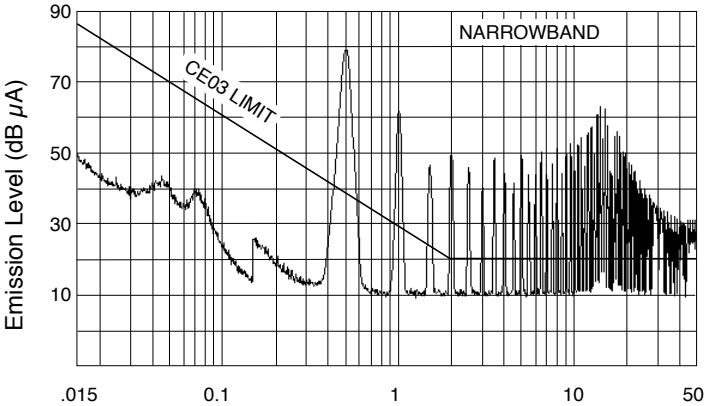

Frequency (MHz), 42 V<sub>IN</sub> Unfiltered  
SMHF4207D MIL-STD-461C, CE03

FIGURE 56

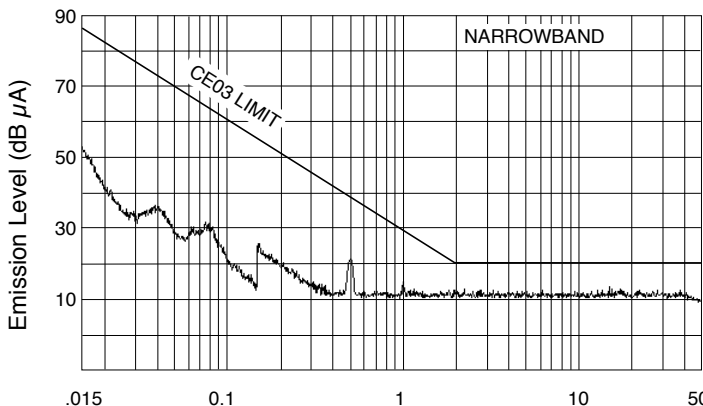

Frequency (MHz), 42 V<sub>IN</sub> with SFMC28-461 EMI Filter  
SMHF4207D MIL-STD-461C, CE03

FIGURE 57



# SMHF42 Single and Dual DC-DC Converters

## 35-55 VOLT INPUT – 15 WATT

TYPICAL PERFORMANCE PLOTS: 25°C CASE, 42 V<sub>IN</sub>, 100% LOAD, UNLESS OTHERWISE SPECIFIED.  
FOR REFERENCE ONLY. NOT GUARANTEED SPECIFICATIONS.

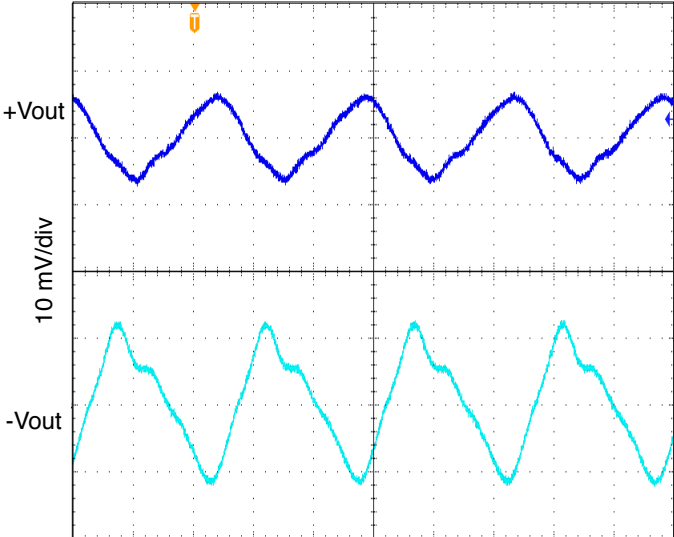

800 nanoseconds/div  
SMHF4207D OUTPUT RIPPLE 2 MHz  
FIGURE 58

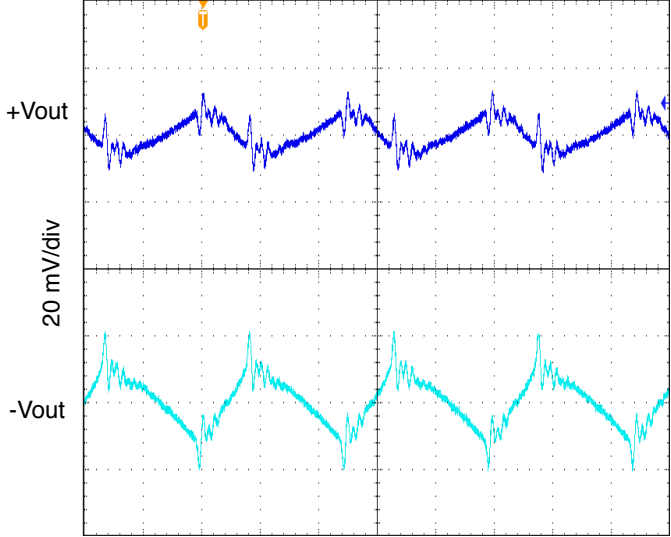

800 nanoseconds/div  
SMHF4207D OUTPUT RIPPLE 10 MHz  
FIGURE 59

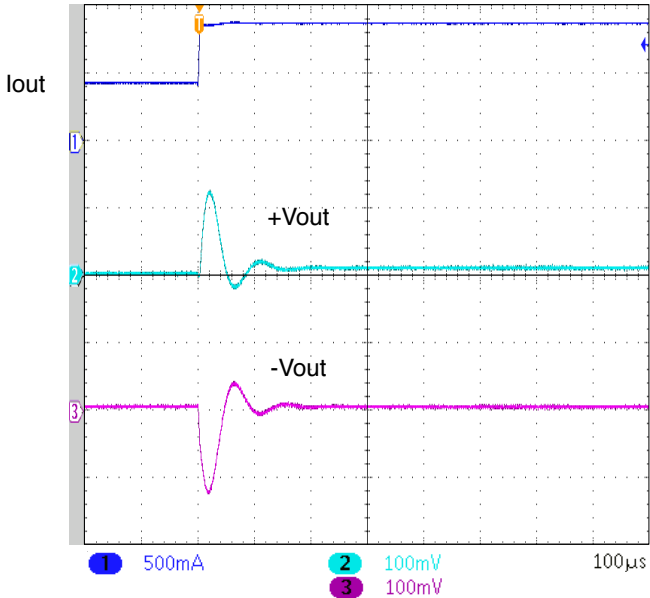

UNITS ARE PER DIVISION  
SMHF4207D STEP LOAD 50% - 100%  
FIGURE 60

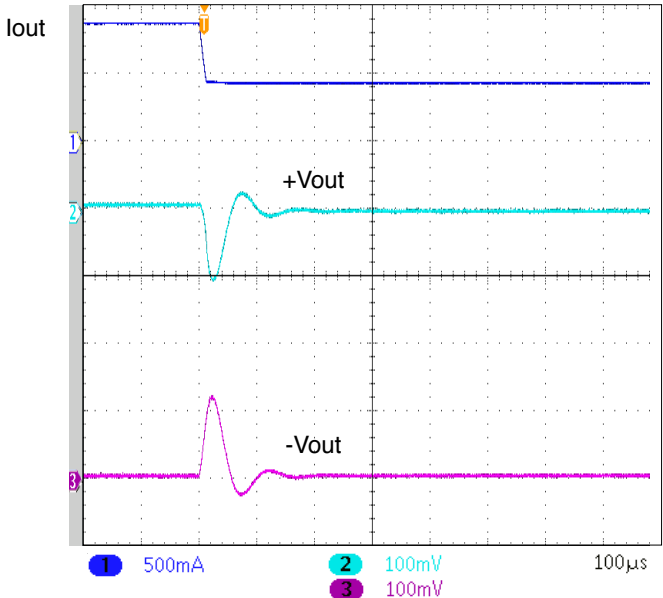

UNITS ARE PER DIVISION  
SMHF4207D STEP LOAD 100% - 50%  
FIGURE 61

# SMHF42 Single and Dual DC-DC Converters

## 35-55 VOLT INPUT – 15 WATT

TYPICAL PERFORMANCE PLOTS: 25°C CASE, 42 V<sub>IN</sub>, 100% LOAD, UNLESS OTHERWISE SPECIFIED.  
FOR REFERENCE ONLY. NOT GUARANTEED SPECIFICATIONS.

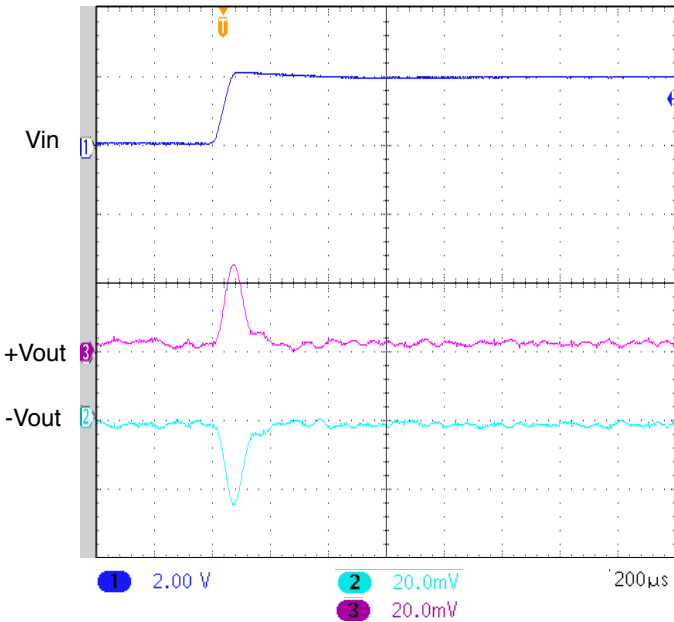

UNITS ARE PER DIVISION  
SMHF4207D STEP LINE 41 - 43 VOLTS IN  
FIGURE 62

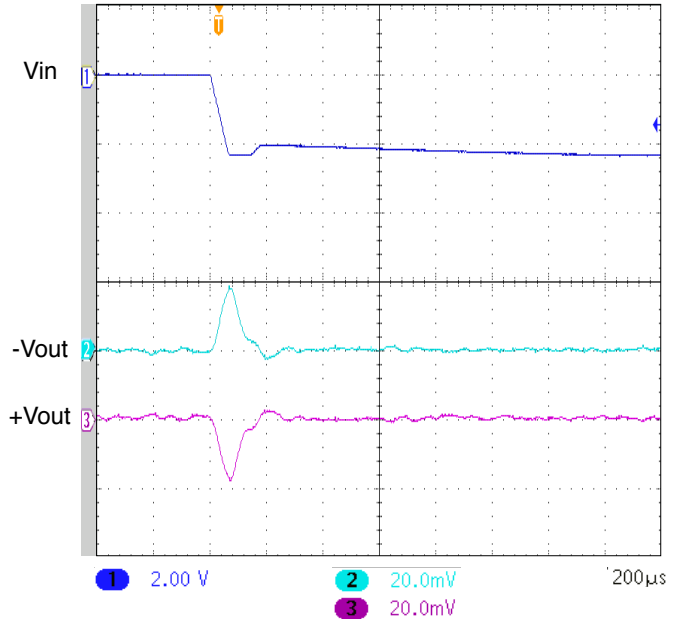

UNITS ARE PER DIVISION  
SMHF4207D STEP LINE 43 - 41 VOLTS IN  
FIGURE 63

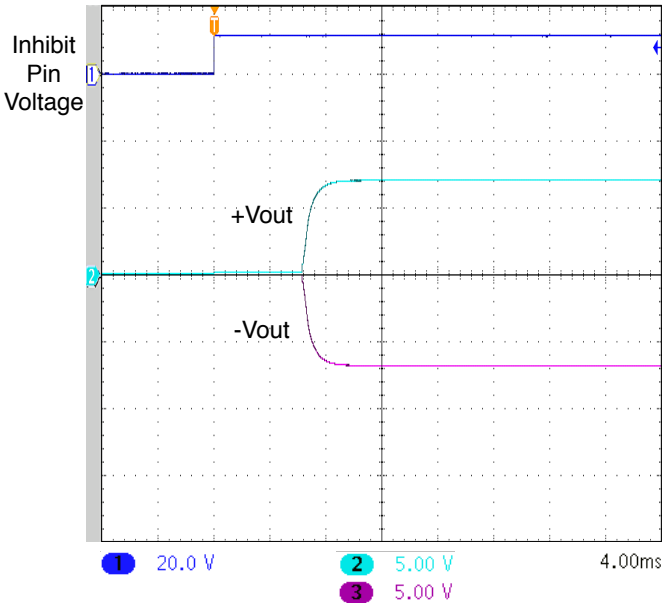

UNITS ARE PER DIVISION  
SMHF4207D START-UP DELAY NO CAP  
FIGURE 64

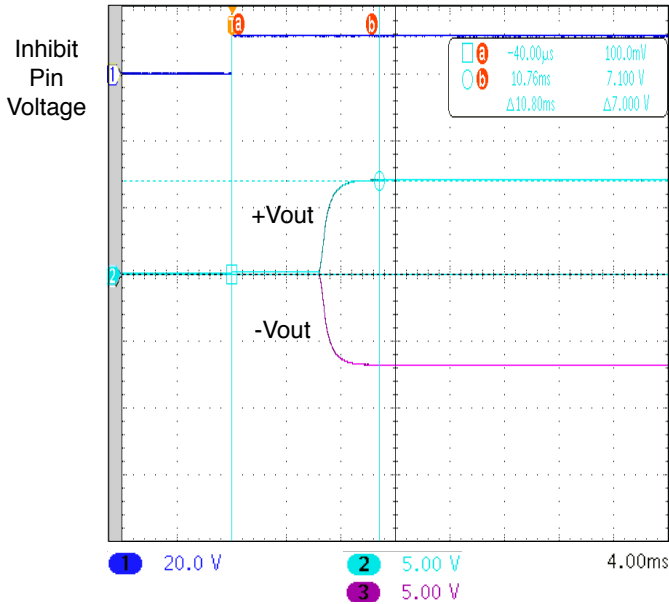

UNITS ARE PER DIVISION  
SMHF4207D START-UP DELAY WITH 100 µF CAP  
FIGURE 65

# SMHF42 Single and Dual DC-DC Converters

## 35-55 VOLT INPUT – 15 WATT

TYPICAL PERFORMANCE PLOTS: 25°C CASE, 42 V<sub>IN</sub>, 100% LOAD, UNLESS OTHERWISE SPECIFIED.  
FOR REFERENCE ONLY. NOT GUARANTEED SPECIFICATIONS.

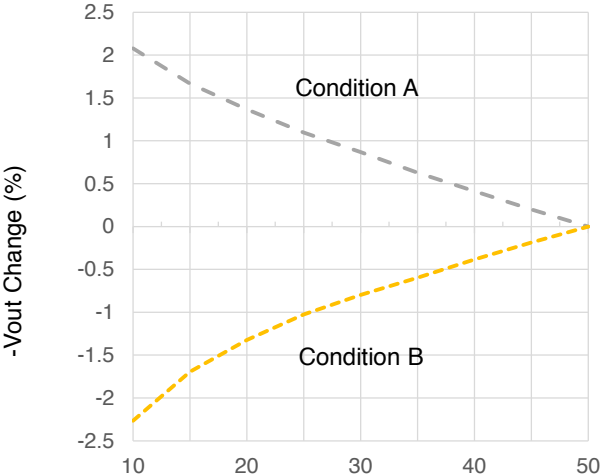

Output Power (%)  
SMHF4207D EFFICIENCY  
FIGURE 66

Condition A:  
+Vout held at 50% load.  
-Vout 10 - 50% load sweep

Condition B:  
-Vout held at 50% load.  
+Vout 10-50% load sweep

# SMHF42 Single and Dual DC-DC Converters

## 35-55 VOLT INPUT – 15 WATT

TYPICAL PERFORMANCE PLOTS: 25°C CASE, 42 V<sub>IN</sub>, 100% LOAD, UNLESS OTHERWISE SPECIFIED.  
FOR REFERENCE ONLY. NOT GUARANTEED SPECIFICATIONS.

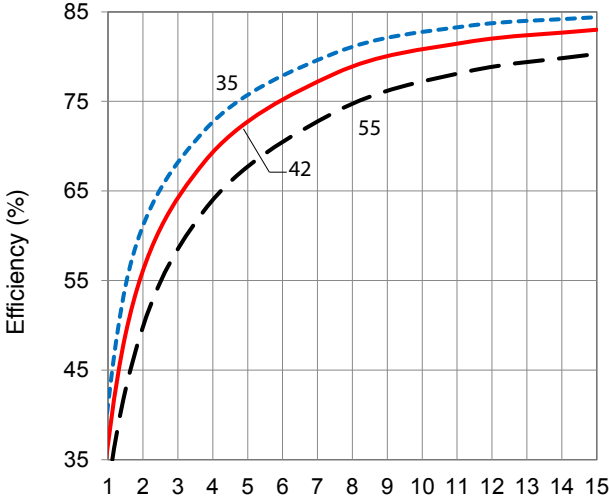

Output Power (Watts)  
SMHF4215D EFFICIENCY  
FIGURE 67

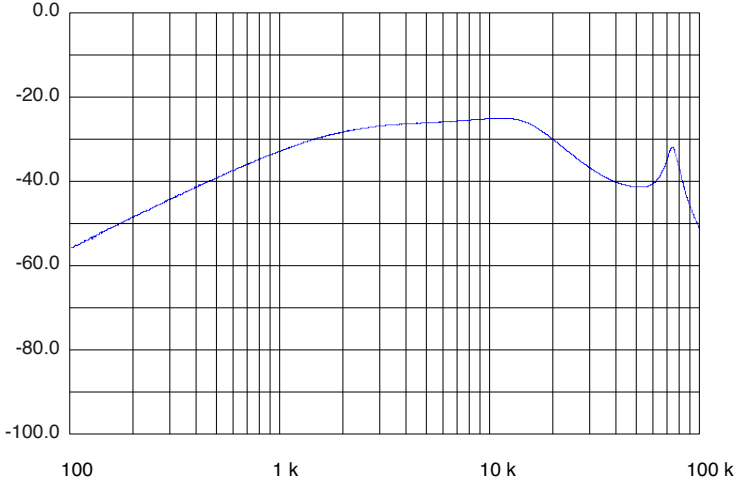

Frequency (Hz), 42 V<sub>IN</sub>  
SMHF4215D AUDIO REJECTION  
FIGURE 68

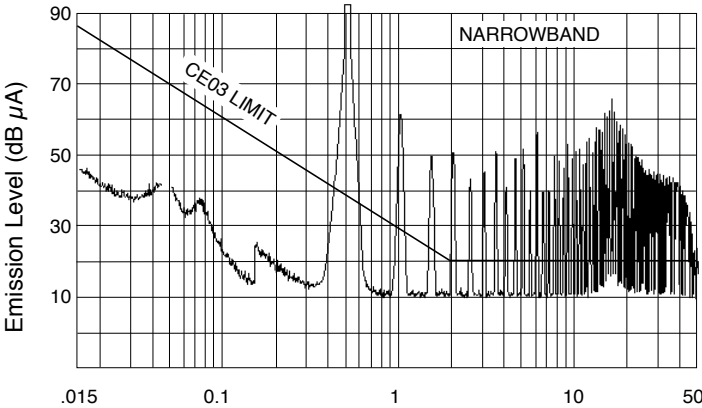

Frequency (MHz), 42 V<sub>IN</sub> Unfiltered  
SMHF4215D MIL-STD-461C, CE03  
FIGURE 69

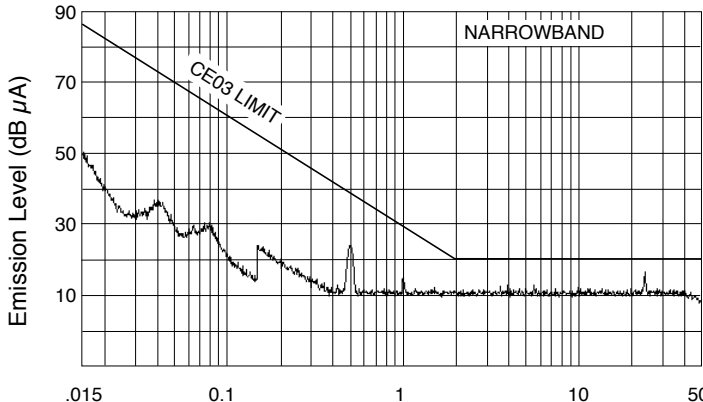

Frequency (MHz), 42 V<sub>IN</sub> with SFMC28-461 EMI Filter  
SMHF4215D MIL-STD-461C, CE03  
FIGURE 70

# SMHF42 Single and Dual DC-DC Converters

## 35-55 VOLT INPUT – 15 WATT

TYPICAL PERFORMANCE PLOTS: 25°C CASE, 42 V<sub>IN</sub>, 100% LOAD, UNLESS OTHERWISE SPECIFIED.  
FOR REFERENCE ONLY. NOT GUARANTEED SPECIFICATIONS.

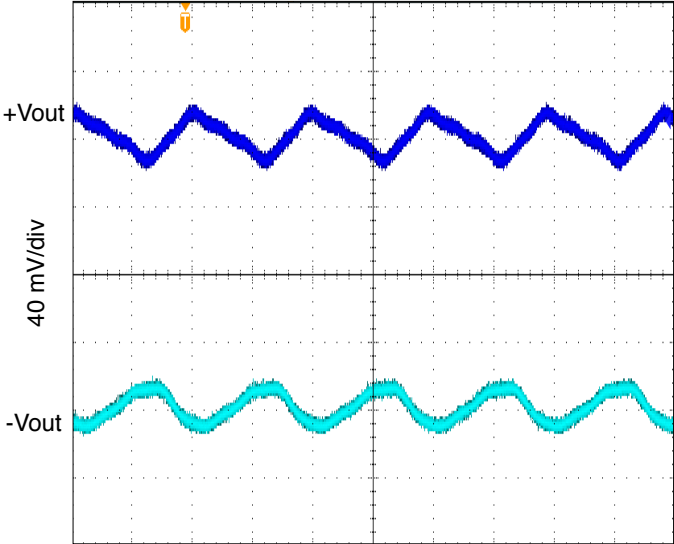

1 microsecond/div  
SMHF4215D OUTPUT RIPPLE 2 MHZ  
FIGURE 71

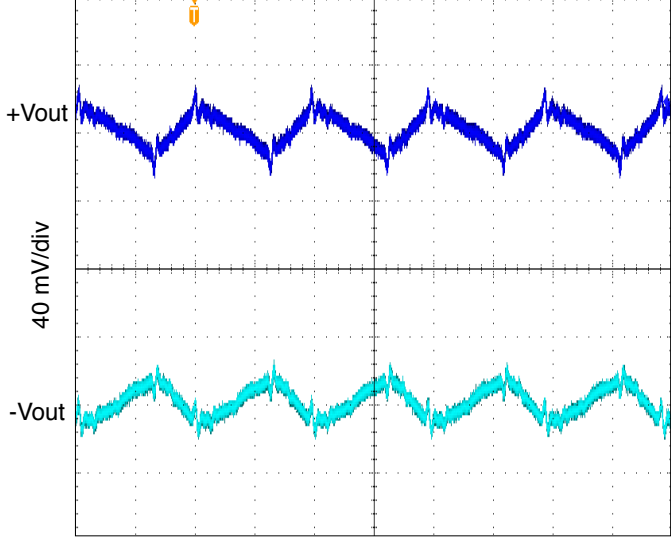

1 microsecond/div  
SMHF4215D OUTPUT RIPPLE 10 MHZ  
FIGURE 72

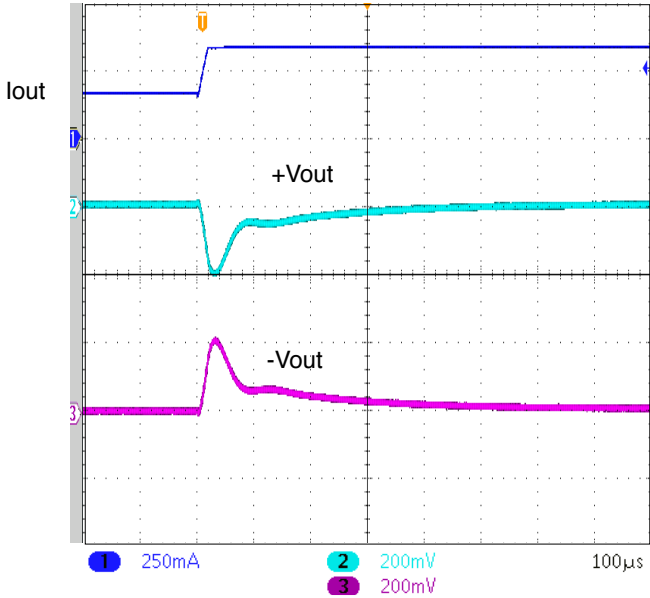

UNITS ARE PER DIVISION  
SMHF4215D STEP LOAD 50% - 100%  
FIGURE 73

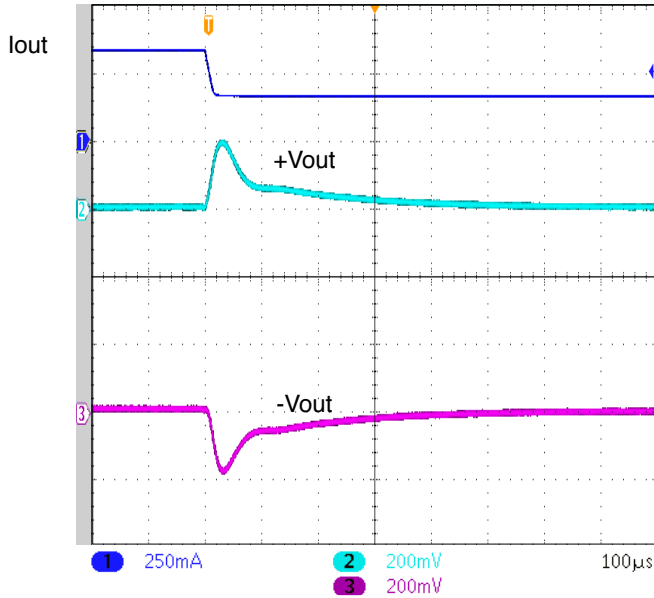

UNITS ARE PER DIVISION  
SMHF4207D STEP LOAD 100% - 50%  
FIGURE 74

# SMHF42 Single and Dual DC-DC Converters

## 35-55 VOLT INPUT – 15 WATT

TYPICAL PERFORMANCE PLOTS: 25°C CASE, 42 V<sub>IN</sub>, 100% LOAD, UNLESS OTHERWISE SPECIFIED.  
FOR REFERENCE ONLY. NOT GUARANTEED SPECIFICATIONS.

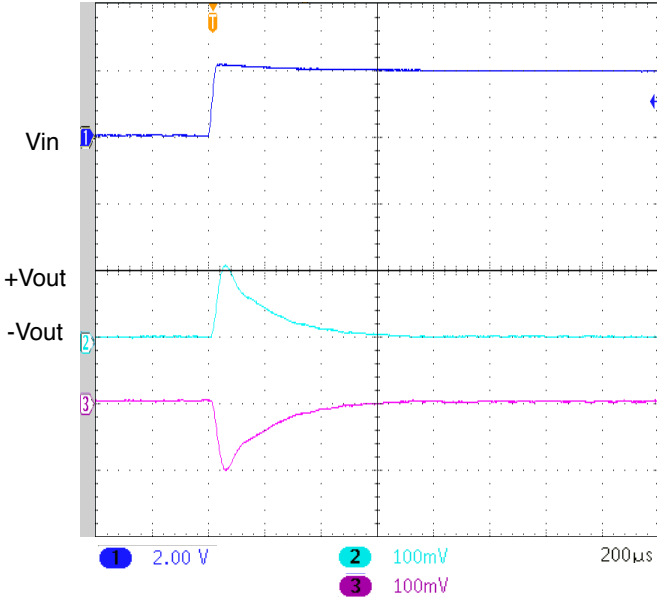

UNITS ARE PER DIVISION  
SMHF4215D STEP LINE 41 - 43 VOLTS IN  
FIGURE 75

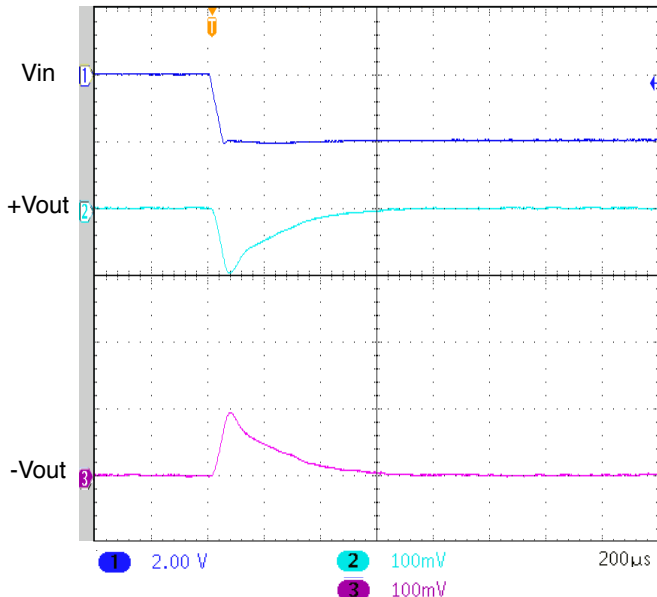

UNITS ARE PER DIVISION  
SMHF4215D STEP LINE 43 - 41 VOLTS IN  
FIGURE 76

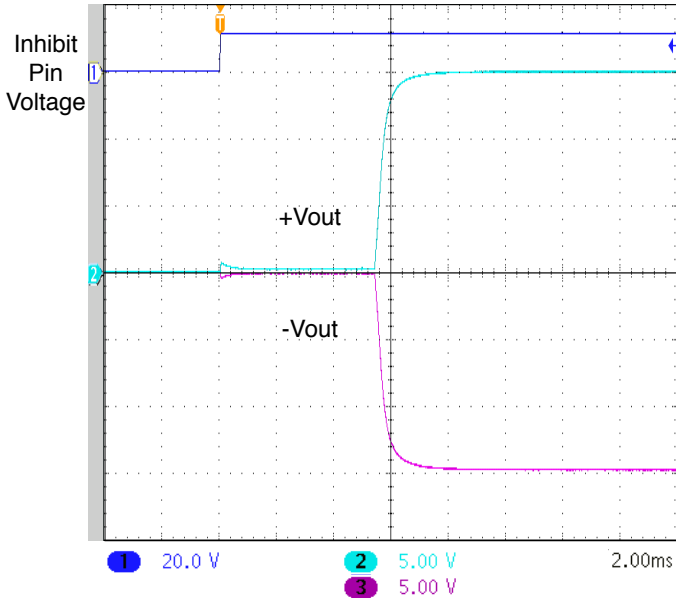

UNITS ARE PER DIVISION  
SMHF4215D START-UP DELAY NO CAP  
FIGURE 77

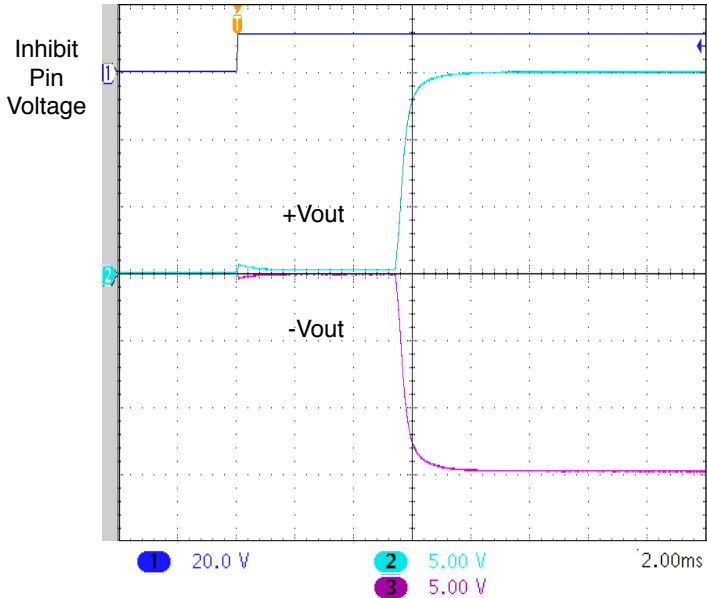

UNITS ARE PER DIVISION  
SMHF4215D START-UP DELAY WITH 100 µF CAP  
FIGURE 78

# SMHF42 Single and Dual DC-DC Converters

## 35-55 VOLT INPUT – 15 WATT

TYPICAL PERFORMANCE PLOTS: 25°C CASE, 42 V<sub>IN</sub>, 100% LOAD, UNLESS OTHERWISE SPECIFIED.  
FOR REFERENCE ONLY. NOT GUARANTEED SPECIFICATIONS.

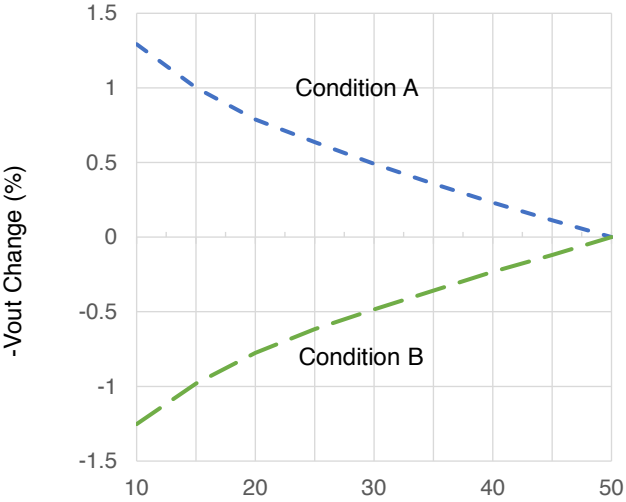

Output Power (%)  
SMHF4215D EFFICIENCY  
FIGURE 79

Condition A:  
+Vout held at 50% load.  
-Vout 10 - 50% load sweep

Condition B:  
-Vout held at 50% load.  
+Vout 10-50% load sweep

# SMHF42 Single and Dual DC-DC Converters

## 35-55 VOLT INPUT – 15 WATT

BOTTOM VIEW CASE E1

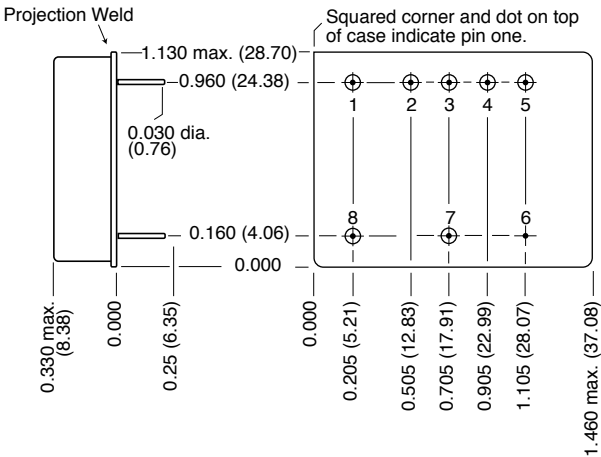

**Weight:** 30 grams maximum

**Case dimensions in inches (mm)**

Tolerance  $\pm 0.005$  (0.13) for three decimal places  
 $\pm 0.01$  (0.3) for two decimal places  
unless otherwise specified

**CAUTION**

Heat from reflow or wave soldering may damage the device. Solder pins individually with heat application not exceeding 300°C for 10 seconds per pin.

**Materials**

- Header Cold Rolled Steel/Nickel/Gold
- Cover Kovar/Nickel
- Pins #52 alloy/Gold compression glass seal.  
Gold plating of 50 - 150 microinches included in pin diameter  
Seal Hole:  $0.080 \pm 0.002$  (2.03  $\pm 0.05$ )

Please refer to the numerical dimensions for accuracy.

FIGURE 80: CASE E1



# SMHF42 Single and Dual DC-DC Converters

## 35-55 VOLT INPUT – 15 WATT

### BOTTOM VIEW CASE G1

Flanged cases: Designator "F" required in Case Option position of model number

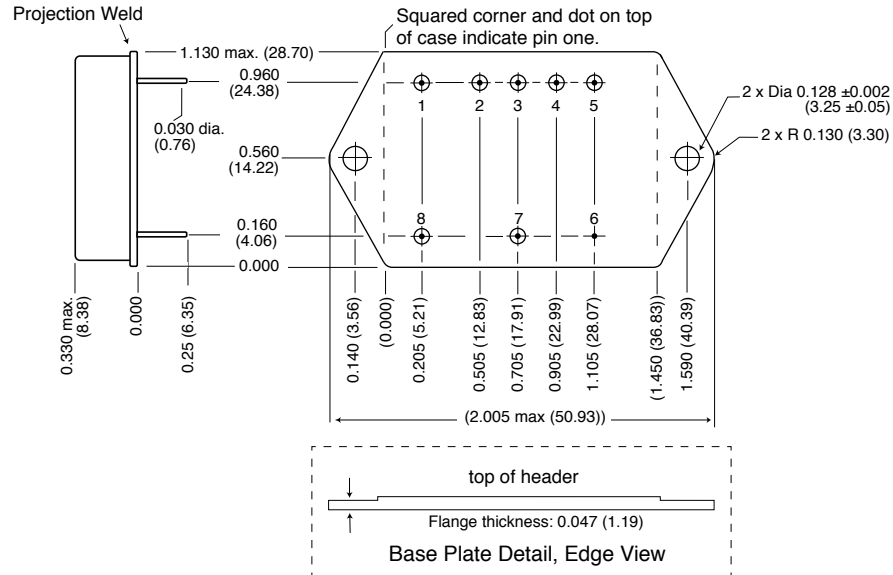

**Weight:** 30 grams maximum

#### Case dimensions in inches (mm)

Tolerance  $\pm$ 0.005 (0.13) for three decimal places  
 $\pm$ 0.01 (0.3) for two decimal places  
 unless otherwise specified

#### CAUTION

Heat from reflow or wave soldering may damage the device. Solder pins individually with heat application not exceeding 300°C for 10 seconds per pin.

#### Materials

Header Cold Rolled Steel/Nickel/Gold  
 Cover Kovar/Nickel  
 Pins #52 alloy/Gold compression glass seal  
 Gold plating of 50 - 150 microinches included in pin diameter  
 Seal Hole: 0.080  $\pm$ 0.002 (2.03  $\pm$ 0.05)

Please refer to the numerical dimensions for accuracy.

FIGURE 81: CASE G1

# SMHF42 Single and Dual DC-DC Converters

## 35-55 VOLT INPUT – 15 WATT

### ELEMENT EVALUATION SPACE DC-DC CONVERTERS PROTOTYPE, CLASS H AND CLASS K

COMPONENT-LEVEL TEST PERFORMED	NON-QML <sup>1</sup>	QML <sup>2</sup>			
	PROTOTYPE	CLASS H		CLASS K	
	/O	/H		/K	
	M/S <sup>3</sup>	M/S <sup>3</sup>	P <sup>4</sup>	M/S <sup>3</sup>	P <sup>4</sup>
Element Electrical	■	■	■	■	■
Visual		■	■	■	■
Internal Visual		■		■	
Temperature Cycling				■	■
Constant Acceleration				■	■
Interim Electrical				■	
Burn-in				■	
Post Burn-in Electrical				■	
Steady State Life				■	
Voltage Conditioning Aging					■
Visual Inspection					■
Final Electrical		■	■	■	■
Wire Bond Evaluation		■	■	■	■
SEM				■	

#### Notes

1. Non-QML products may not meet all of the requirements of MIL-PRF-38534.
2. Screened to MIL-PRF-38534. Class H and K are pending product validation.
3. M/S = Active components (microcircuit and semiconductor die)
4. P = Passive components, Class H and K element evaluation. Not applicable to space prototype ("O") element evaluation.

#### Definitions

Element Evaluation: Component testing/screening per MIL-STD-883 as determined by MIL-PRF-38534  
SEM: scanning electron microscopy

TABLE 10: ELEMENT EVALUATION—DC-DC CONVERTERS PROTOTYPE, CLASS H AND CLASS K

# SMHF42 Single and Dual DC-DC Converters

## 35-55 VOLT INPUT – 15 WATT

### ENVIRONMENTAL SCREENING SPACE DC-DC CONVERTERS PROTOTYPE, CLASS H AND CLASS K

TEST PERFORMED	NON-QML <sup>1</sup>	QML <sup>2, 3</sup>			
	PROTOTYPE	CLASS H		CLASS K	
	/OO <sup>4</sup>	/HL	/HR	/KL	/KR
<b>Non-destruct wire bond pull, Method 2023</b>		■ <sup>5</sup>	■ <sup>5</sup>	■	■
<b>Pre-cap Inspection, Method 2017, 2032</b>	■	■	■	■	■
<b>Temperature Cycle (10 times)</b> Method 1010, Cond. C, -65°C to +150°C, ambient	■	■	■	■	■
<b>Constant Acceleration</b> Method 2001, 3000 g	■	■	■	■	■
<b>PIND, Test Method 2020, Cond. A</b>		■ <sup>5</sup>	■ <sup>5</sup>	■	■
<b>Pre burn-in test, Group A, Subgroups 1 and 4</b>	■	■ <sup>5</sup>	■ <sup>5</sup>	■	■
<b>Burn-in Method 1015, +125°C case, typical <sup>6</sup></b>					
96 hours	■				
160 hours		■	■		
2 x 160 hours (includes mid-BI test)				■	■
<b>Final Electrical Test, MIL-PRF-38534, Group A,</b>					
Subgroups 1 and 4: +25°C case	■				
Subgroups 1 through 6, -55°C, +25°C, +125°C case		■	■	■	■
<b>Hermeticity Test, Method 1014</b>					
Gross Leak, Cond. B <sub>2</sub> , Kr85				■	■
Gross Leak, Cond. C <sub>1</sub> , fluorocarbon	■	■	■		
Fine Leak, Cond. B <sub>1</sub> , Kr85				■	■
Fine Leak, Cond. A <sub>2</sub> , helium	■	■	■		
<b>Radiography, Method 2012</b>				■	■
<b>Post Radiography Electrical Test, +25°C case</b>				■ <sup>5</sup>	■ <sup>5</sup>
<b>Final visual inspection, Method 2009</b>	■	■	■	■	■

Test methods are referenced to MIL-STD-883 as determined by MIL-PRF-38534.

#### Notes

- Non-QML prototype products may not meet all of the requirements of MIL-PRF-38534.
- All processes are QML qualified and performed by certified operators.
- Screened to MIL-PRF-38534. Class H, Class K, RHA L, RHA R, and SEE are pending product validation.
- "O" in the RHA designator position in Interpoint model numbers indicates DLA RHA "-" defined as no RHA.
- Not required by DLA but performed to assure product quality.
- Burn-in temperature designed to bring the case temperature to +125°C minimum. Burn-in is a powered test.

TABLE 11: ENVIRONMENTAL SCREENING DC-DC CONVERTERS PROTOTYPE, CLASS H AND CLASS K

# SMHF42 Single and Dual DC-DC Converters

35-55 VOLT INPUT – 15 WATT

## SPACE RADIATION HARDNESS ASSURANCE SCREENING DC-DC CONVERTERS CLASS H AND CLASS K, RHA <sup>1</sup> L AND R

QUALIFICATION PER MIL-STD	NON-QML <sup>2</sup>	QML <sup>3</sup>			
	PROTOTYPE	CLASS H		CLASS K	
	/OO <sup>4</sup>	/HL	/HR	/KL	/KR
RHA L: 50 krad(Si) total dose <sup>1, 5, 6</sup>		■		■	
RHA R: 100 krad(Si) total dose <sup>1, 5, 6</sup>			■		■
SEE, LET 86 MeV cm <sup>2</sup> /mg <sup>1, 7</sup>		■	■	■	■

Test methods are referenced to MIL-STD-883 as determined by MIL-PRF-38534.

Notes

- Our Redmond facility has a DLA approved RHA plan for Interpoint power products. Our SMD products with RHA "L" or "R" code meet DLA requirements.
- Non-QML prototype products may not meet all of the requirements of MIL-PRF-38534.
- Screened to MIL-PRF-38534. Class H, Class K, RHA L, RHA R, and SEE are pending product validation.
- "O" in the RHA designator position in Interpoint model numbers indicates DLA RHA "-" defined as no RHA.
- Radiation sensitive components internal to the devices are procured with radiation guarantees or undergo radiation lot acceptance testing (RLAT) performed per condition A, method 1019 of MIL-STD-883.
- A representative converter was high dose rate (HDR) tested using condition A of method 1019 of MIL-STD-883 to 150 krad(Si) to ensure RHA designator level "R" (100 krad(Si)). Pending product validation.
- Single event testing was performed on a converter to 86 MeV-cm<sup>2</sup>/mg using 15 MeV/nucleon gold ions with no latch-up, burn-out, functional interrupts, or gate ruptures exhibited. Single event upsets (output voltage transients) may be present up to 86 MeV-cm<sup>2</sup>/mg. Pending product validation.

TABLE 12: SPACE RADIATION HARDNESS ASSURANCE DC-DC CONVERTERS CLASS H AND CLASS K, RHA L AND R

