

# SMFL Single and Dual DC-DC Converters

## 28 VOLT INPUT – 65 WATT

### FEATURES

- Radiation tolerant space DC-DC converter
  - Single event effects (SEE) LET performance to 86 MeV cm<sup>2</sup>/mg
  - Total ionizing dose (TID) guaranteed per MIL-STD-883 method 1019, radiation hardness assurance (RHA) P = 30 krad(Si), L = 50 krad(Si), R = 100 krad(Si)
  - 50 - 300 rad(Si)/sec dose rate (Condition A)
  - 10 mrad(Si)/sec dose rate (Condition D)
- Parallel up to 3 converters—maximum recommended power is 80% of the total available power.
- Operating temperature -55°C to +125°C
- Qualified to MIL-PRF-38534 Class H and K
- Input voltage range 16 to 40 volts
- Transient protection up to 80 volts for 50 ms
  - Converter will shut down at an input voltage above approximately 45 volts
- Fully isolated, magnetic feedback
- Fixed high switching frequency
- Remote sense and output trim on single output models
- Primary and secondary inhibit function
- Synchronization input and output
- Indefinite short circuit protection
- High power density with up to 85% typical efficiency



MODELS	
OUTPUT VOLTAGE (V)	
SINGLE	DUAL
3.3	±5
5	±12
12	±15
15	

### DESCRIPTION

The Interpoint® SMFL Series™ 28 volt DC-DC converters are rated up to 65 watts output power over a -55°C to +125°C temperature range with a 28 volt nominal input. On dual output models, up to 70% of the rated output power can be drawn from either the positive or negative outputs. The welded, hermetically sealed package is only 3.005 x 1.505 x 0.400 inches.

### SCREENING

SMFL converters offer screening options to space prototype (O), Class H or K and radiation hardness assurance (RHA) levels P - 30 krad(Si), L - 50 krad(Si) or R - 100 krad(Si). Single event effects (SEE) LET performance to 86 MeV cm<sup>2</sup>/mg. See Table 9 on page 13 and Table 10 on page 14 for more information.

### DESIGN FEATURES

The SMFL Series converters are switching regulators that use a quasi-square wave, single ended forward converter design with a constant switching frequency of 600 kHz.

Isolation between input and output circuits is provided with a transformer in the forward path and wide bandwidth magnetic coupling in the feedback control loop. The SMFL Series uses a unique dual loop feedback technique that controls output current with an inner feedback loop and output voltage with a cascaded voltage mode feedback loop.

The additional secondary current mode feedback loop improves transient response in a manner similar to primary current mode control and allows for ease of paralleling.

Tight load regulation is achieved through a wide-bandwidth magnetic feedback circuit.

### INHIBIT

The SMFL Series converters have two inhibit terminals (Inhibit 1 and Inhibit 2) that can be used to disable power conversion, resulting in a very low quiescent input current. See Table 5 on page 6 for specifications.

### SYNC

Converters may be synced to an external clock (525 to 675 kHz) or to one another by using the sync in or out pins. See Table 5 on page 6 for specifications.

# SMFL Single and Dual DC-DC Converters

## 28 VOLT INPUT – 65 WATT

### SENSE AND TRIM

Single output models provide sense to maintain voltage at the load. The converters output voltage can also be trimmed up. See Figure 1.

The units designated as slaves have the Master/Inhibit 2 pin (pin 12) connected to the Sense Return pin (pin 9) of the master unit. Figure 2 on page 3 shows the typical setup for two or three units in parallel.

### CURRENT SHARING AND PARALLEL OPERATION

For increased power parallel up to 3 converters. The maximum recommended power is 80% of the total available power. Multiple SMFL converters may be used in parallel to drive a common load. Only single output models with Sense and Sense Return can be used in the share mode. In this mode of operation the load current is shared by two or three SMFL converters.

A second slave unit may be placed in parallel with a master and slave; this requires the Triple pin (pin 3) of the master unit to be connected to the Sense Return pins (pin 9) shown in Figure 2 on page 3.

In current sharing mode, one SMFL converter is designated as a master. The Slave pin (pin 11) of the master is left unconnected and the Master/Inhibit 2 pin (pin 12) of the master is connected to the Slave pin (pin 11) of the slave units.

In current sharing mode, the converters function as a current source. For this reason it is important that their outputs be connected to the common ground at all times to prevent an excessively high voltage at their outputs.

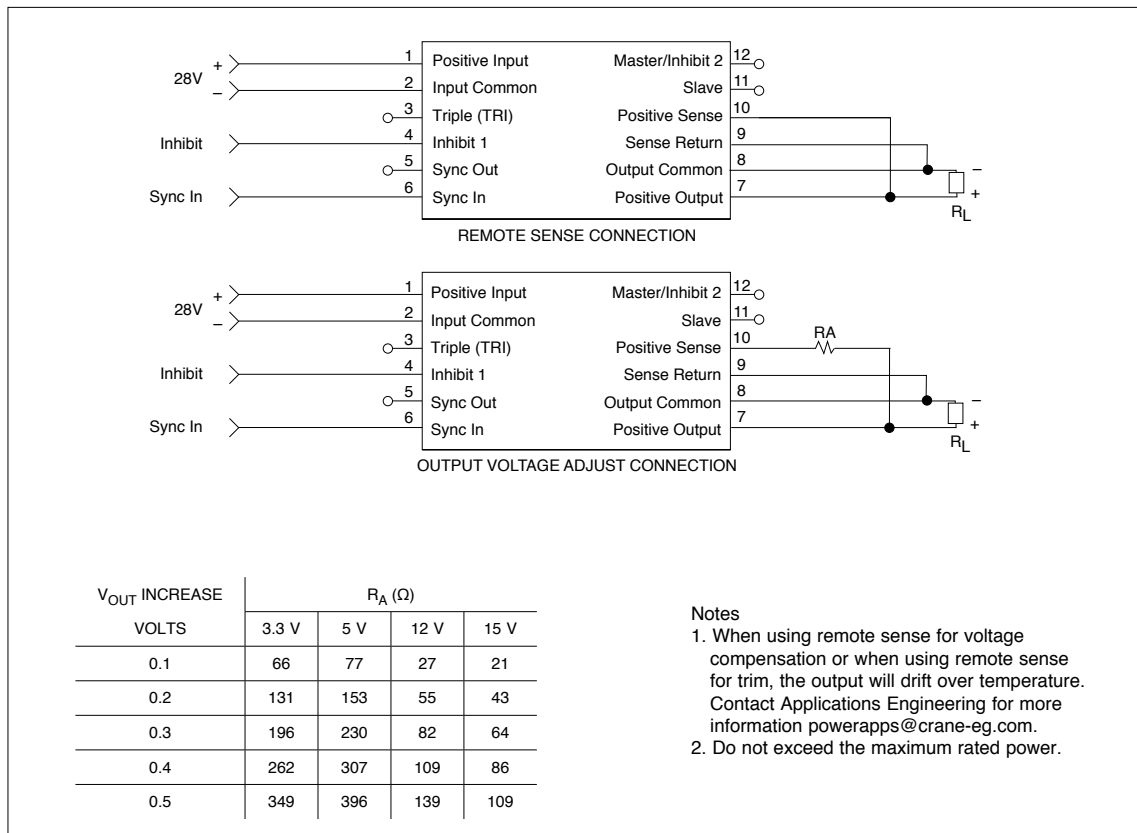

FIGURE 1: SENSE CONNECTIONS AND TRIM TABLE – SINGLE OUTPUT MODELS

# SMFL Single and Dual DC-DC Converters

## 28 VOLT INPUT – 65 WATT

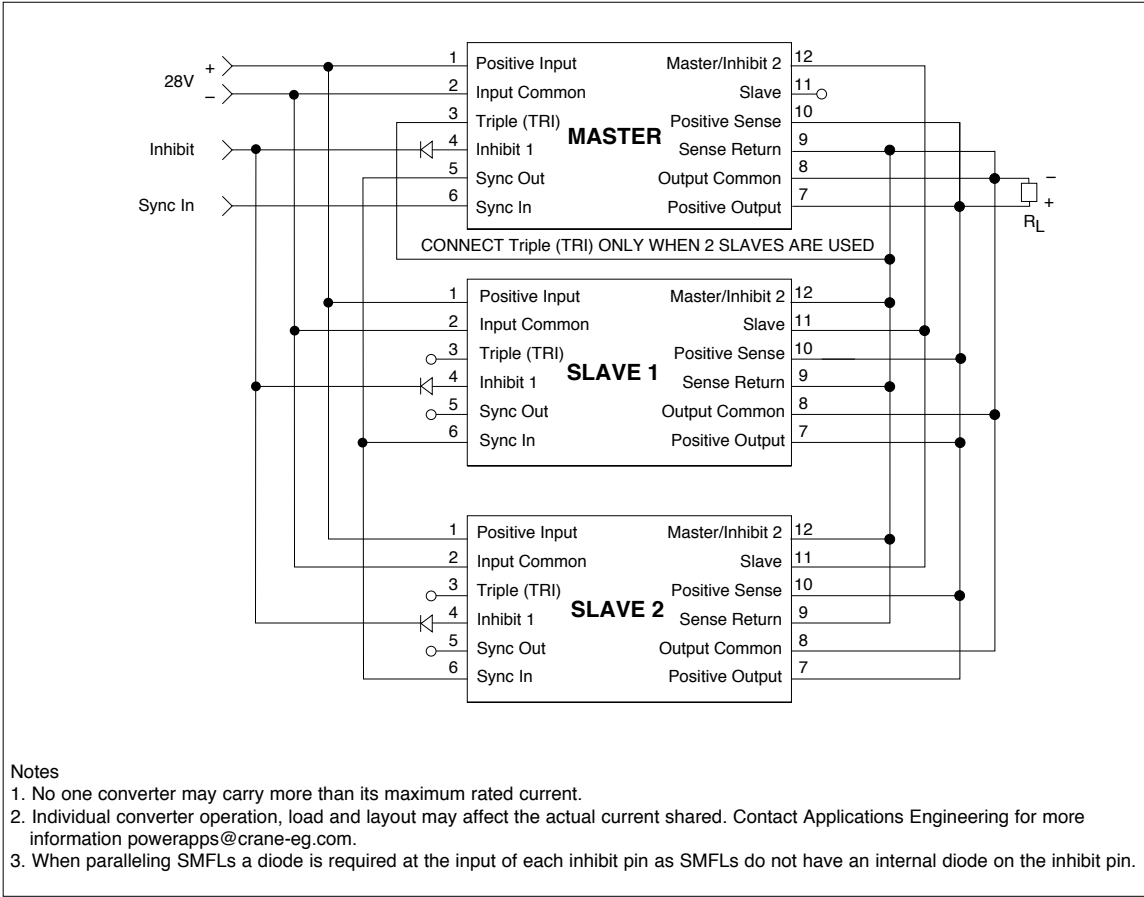

FIGURE 2: PARALLEL CONNECTIONS – SINGLE OUTPUT MODELS

# SMFL Single and Dual DC-DC Converters

## 28 VOLT INPUT – 65 WATT

PIN OUT		
Pin	Single Output	Dual Output
1	Positive Input	Positive Input
2	Input Common	Input Common
3	Triple (TRI)	Triple (TRI)
4	Inhibit 1 (INH1)	Inhibit 1 (INH1)
5	Sync Out	Sync Out
6	Sync In	Sync In
7	Positive Output	Positive Output
8	Output Common	Output Common
9	Sense Return	Negative Output
10	Positive Sense	No connection
11	Slave	Slave
12	Master/Inhibit 2 (MSTR/INH2)	Master/Inhibit 2 (MSTR/INH2)

TABLE 1: PIN OUT

PINS NOT IN USE	
Triple (TRI)	Leave unconnected
Inhibit 1 (INH1)	Leave unconnected
Sync Out	Leave unconnected
Sync In	Connect to Input Common
Sense Return	Connect to appropriate outputs
Positive Sense	Connect to appropriate outputs
Slave	Leave unconnected
Master/Inhibit 2 (MSTR/INH2)	Leave unconnected

TABLE 2: PINS NOT IN USE

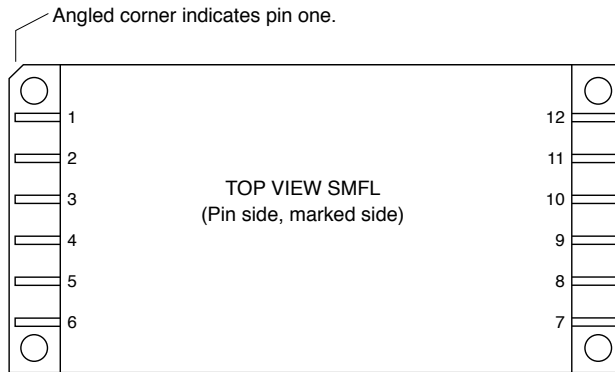

See Figure 18 on page 12 for dimensions.

FIGURE 3: PIN OUT

# SMFL Single and Dual DC-DC Converters

## 28 VOLT INPUT – 65 WATT

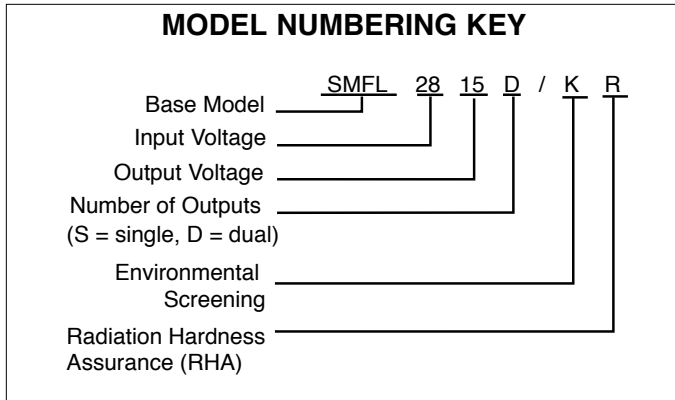

FIGURE 4: MODEL NUMBERING KEY

<b>SMD NUMBERS</b>	
STANDARD MICROCIRCUIT DRAWING (SMD)	SMFL SERIES SIMILAR PART
5962R0621301KXC	SMFL283R3S/KR
5962R9316301KXC	SMFL2805S/KR
5962R9316201KXC	SMFL2812S/KR
5962R9316101KXC	SMFL2815S/KR
5962R9319101KXC	SMFL2805D/KR
5962R9319201KXC	SMFL2812D/KR
5962R9319301KXC	SMFL2815D/KR

The SMD number shown is for Class K screening, non-flanged, radiation hardness assurance (RHA) level R. For exact specifications for an SMD product, refer to the SMD drawing. SMDs can be downloaded from <https://landandmaritimeapps.dla.mil/programs/smcr/>

TABLE 3: SMD NUMBER CROSS REFERENCE

<b>MODEL NUMBER OPTIONS</b>					
TO DETERMINE THE MODEL NUMBER ENTER ONE OPTION FROM EACH CATEGORY IN THE FORM BELOW.					
CATEGORY	Base Model and Input Voltage	Output Voltage <sup>1</sup>	Number of Outputs <sup>2</sup>	Screening <sup>3</sup>	RHA <sup>4</sup>
<b>OPTIONS</b>	SMFL28	3R3, 05, 12, 15	S	O	O
		05, 12, 15	D	H	P
				K	L R
<b>FILL IN FOR MODEL #</b>	SMFL28	_____	_____	/ _____	_____

**Notes**

- Output Voltage: An R indicates a decimal point. 3R3 is 3.3 volts out. The value of 3R3 is only available in single output models.
- Number of Outputs: S is a single output and D is a dual output.
- Screening: A screening level of O is a space prototype and is only used with RHA O. See Table 9 on page 13 and Table 10 on page 14 for more information.
- RHA: Interpoint model numbers use an "O" in the RHA designator position to indicate the "-" (dash) RHA level of MIL-PRF-38534, which is defined as "no RHA." RHA O is only available with screening level O. See Table 10 on page 14 for more information.

TABLE 4: MODEL NUMBER OPTIONS

# SMFL Single and Dual DC-DC Converters

## 28 VOLT INPUT – 65 WATT

TABLE 5: OPERATING CONDITIONS, ALL MODELS, 25°C CASE, 28 VIN, 100% LOAD, UNLESS OTHERWISE SPECIFIED.

PARAMETER	CONDITIONS	ALL MODELS			UNITS
		MIN	TYP	MAX	
LEAD SOLDERING TEMPERATURE <sup>1</sup>	10 SECONDS MAX.	—	—	300	°C
STORAGE TEMPERATURE <sup>1</sup>		-65	—	+150	°C
CASE OPERATING TEMPERATURE	FULL POWER	-55	—	+125	°C
	ABSOLUTE <sup>1</sup>	-55	—	+135	
DERATING OUTPUT POWER/CURRENT <sup>1</sup>	LINEARLY	From 100% at 125°C to 0% at 135°C			
ESD RATING <sup>1</sup> MIL-PRF-38534, 3.9.5.8.2	MIL STD 883 METHOD 3015 CLASS 3B	>8000			V
ISOLATION: INPUT TO OUTPUT OR ANY PIN TO CASE	@ 500 VDC AT 25°C	100	—	—	Megohms
INPUT TO OUTPUT CAPACITANCE <sup>1</sup>		—	150	—	pF
CURRENT LIMIT <sup>2</sup>	% OF FULL LOAD	—	125	—	%
UNDERVOLTAGE LOCKOUT <sup>1</sup> -55°C TO +125°C	RISING V <sub>IN</sub> (TURN ON)	14.1	—	15.8	V
	FALLING V <sub>IN</sub> (TURN OFF)	11.6	—	14.0	
AUDIO REJECTION <sup>1</sup>		—	50	—	dB
CONVERSION FREQUENCY, FREE RUN	-55°C TO +125°C	525	—	675	kHz
SYNCHRONIZATION IN -55°C TO +125°C	INPUT FREQUENCY	525	—	675	kHz
	DUTY CYCLE <sup>1</sup>	40	—	60	%
	ACTIVE LOW	—	—	0.8	V
	ACTIVE HIGH <sup>1</sup>	4.5	—	5.0	
	REFERENCED TO	INPUT COMMON			
IF NOT USED	CONNECT TO INPUT COMMON				
SYNCHRONIZATION OUT	REFERENCED TO	INPUT COMMON			
	IF NOT USED	LEAVE UNCONNECTED			
<b>INHIBIT 1</b> ACTIVE LOW (OUTPUT DISABLED) Do not apply a voltage to the inhibit pin. <sup>3</sup>	INHIBIT PIN PULLED LOW	—	—	0.8	V
	INHIBIT PIN SOURCE CURRENT <sup>1</sup>	—	—	10	mA
	REFERENCED TO	INPUT COMMON			
<b>INHIBIT 1</b> ACTIVE HIGH (OUTPUT ENABLED) Do not apply a voltage to the inhibit pin. <sup>3</sup>	INHIBIT PIN CONDITION	OPEN COLLECTOR OR UNCONNECTED			
	OPEN INHIBIT PIN VOLTAGE <sup>1</sup>	9	—	12	V
<b>INHIBIT 2</b> ACTIVE LOW (OUTPUT DISABLED) Do not apply a voltage to the inhibit pin. <sup>3</sup>	INHIBIT PIN PULLED LOW	—	—	0.5	V
	INHIBIT PIN SOURCE CURRENT <sup>1</sup>	—	—	5	mA
	REFERENCED TO	OUTPUT COMMON			
<b>INHIBIT 2</b> ACTIVE HIGH (OUTPUT ENABLED) Do not apply a voltage to the inhibit pin. <sup>3</sup>	INHIBIT PIN CONDITION	OPEN COLLECTOR OR UNCONNECTED			
	OPEN INHIBIT PIN VOLTAGE <sup>1</sup>	—	—	9	V

*For mean time between failures (MTBF) contact Applications Engineering  
powerapps@craneae.com*

- Notes
1. Guaranteed by characterization test and/or analysis. Not a production test.
  2. Dual outputs: The over-current limit will trigger when the sum of the currents from both outputs reaches 125% (typical value) of the maximum rated "total" current of both outputs.
  3. An external inhibit interface should be used to pull the inhibits low or leave them floating. The inhibit pins can be left unconnected if not used.

# SMFL Single and Dual DC-DC Converters

## 28 VOLT INPUT – 65 WATT

TABLE 6: ELECTRICAL CHARACTERISTICS: -55°C TO +125°C CASE, 28 VIN, 100% LOAD, FREE RUN, UNLESS OTHERWISE SPECIFIED.

SINGLE OUTPUT MODELS		SMFL283R3S			SMFL2805S			UNITS
PARAMETER	CONDITIONS	MIN	TYP	MAX	MIN	TYP	MAX	
OUTPUT VOLTAGE		3.21	3.30	3.39	4.87	5.00	5.13	V
OUTPUT CURRENT	$V_{IN} = 16 \text{ TO } 40 \text{ V}$	0	—	12.12	0	—	10	A
OUTPUT POWER	$V_{IN} = 16 \text{ TO } 40 \text{ V}$	0	—	40	0	—	50	W
OUTPUT RIPPLE	$T_C = 25^\circ\text{C}$	—	10	35	—	15	35	mV p-p
10 kHz - 2 MHz	$T_C = -55^\circ\text{C TO } +125^\circ\text{C}$	—	10	50	—	30	50	
LINE REGULATION	$V_{IN} = 16 \text{ TO } 40 \text{ V}$	—	0	20	—	0	20	mV
LOAD REGULATION	NO LOAD TO FULL	—	—	40	—	—	20	mV
INPUT VOLTAGE	CONTINUOUS	16	28	40	16	28	40	V
	TRANSIENT 50 ms <sup>1, 2</sup>	—	—	80	—	—	80	
INPUT CURRENT	NO LOAD	—	70	100	—	70	120	mA
	INHIBITED – INH1	—	9	14	—	9	14	
	INHIBITED – INH2	—	35	70	—	35	70	
INPUT RIPPLE	10 kHz - 10 MHz	—	30	50	—	30	50	mA p-p
EFFICIENCY <sup>3</sup>	$T_C = 25^\circ\text{C}$	71	—	—	75	78	—	%
	$T_C = -55^\circ\text{C TO } +125^\circ\text{C}$	69	—	—	73	—	—	
LOAD FAULT	POWER DISSIPATION	—	12.5	16	—	12.5	18	W
SHORT CIRCUIT	RECOVERY <sup>1</sup>		1.5	6		1.5	4	ms
STEP LOAD RESPONSE <sup>4, 5</sup>	TRANSIENT	—	±200	±300	—	±250	±350	mV pk
	RECOVERY <sup>1</sup>	—	1.5	3.0	—	1.5	3.0	ms
STEP LINE RESPONSE <sup>1, 4, 6</sup>	TRANSIENT	—	±250	±300	—	±250	±300	mV pk
	RECOVERY	—	200	300	—	200	300	μs
START-UP <sup>7</sup>	DELAY	—	3.5	10	—	3.5	6	ms
	OVERSHOOT <sup>1</sup>	—	—	25	—	—	25	mV pk
CAPACITIVE LOAD <sup>1, 8</sup>	$T_C = 25^\circ\text{C}$	—	—	1000	—	—	1000	μF

#### Notes

1. Guaranteed by characterization test and/or analysis. Not a production test.
2. Converter will shut down above approximately 45V but will be undamaged and will restart when voltage drops into normal range.
3. "OO" product may be 2% lower.
4. Recovery time is measured from application of the transient to point at which Vout is within 1% of final value.
5. Step load test is performed at 10 microseconds typical.
6. Step line test is performed at 100 microseconds ± 20 microseconds.
7. Tested on release from inhibit.
8. No affect on dc performance.

# SMFL Single and Dual DC-DC Converters

## 28 VOLT INPUT – 65 WATT

TABLE 7: ELECTRICAL CHARACTERISTICS: -55°C TO +125°C CASE, 28 VIN, 100% LOAD, FREE RUN, UNLESS OTHERWISE SPECIFIED.

SINGLE OUTPUT MODELS		SMFL2812S			SMFL2815S			UNITS
PARAMETER	CONDITIONS	MIN	TYP	MAX	MIN	TYP	MAX	
OUTPUT VOLTAGE		11.76	12.00	12.24	14.55	15.00	15.45	V
OUTPUT CURRENT	V <sub>IN</sub> = 16 TO 40 V	0	—	5	0	—	4.33	A
OUTPUT POWER	V <sub>IN</sub> = 16 TO 40 V	0	—	60	0	—	65	W
OUTPUT RIPPLE	T <sub>C</sub> = 25°C	—	0	75	—	30	85	mV p-p
10 kHz - 2 MHz	T <sub>C</sub> = -55°C TO +125°C	—	45	100	—	45	110	
LINE REGULATION	V <sub>IN</sub> = 16 TO 40 V	—	0	20	—	0	20	mV
LOAD REGULATION	NO LOAD TO FULL	—	—	20	—	—	20	mV
INPUT VOLTAGE	CONTINUOUS	16	28	40	16	28	40	V
	TRANSIENT 50 ms <sup>1, 2</sup>	—	—	80	—	—	80	
INPUT CURRENT	NO LOAD	—	50	100	—	50	100	mA
	INHIBITED – INH1	—	9	14	—	9	14	
	INHIBITED – INH2	—	35	70	—	35	70	
INPUT RIPPLE	10 kHz - 10 MHz	—	30	50	—	30	50	mA p-p
EFFICIENCY <sup>3</sup>	T <sub>C</sub> = 25°C	81	84	—	82	85	—	%
	T <sub>C</sub> = -55°C TO +125°C	79	—	—	80	—	—	
LOAD FAULT	POWER DISSIPATION	—	10	16	—	10	16	W
SHORT CIRCUIT	RECOVERY <sup>1</sup>		1.5	4		1.5	4	ms
STEP LOAD RESPONSE <sup>4, 5</sup>	TRANSIENT	—	±450	±600	—	±500	±600	mV pk
	RECOVERY <sup>1</sup>	—	1.5	3.0	—	1.5	3.0	ms
STEP LINE RESPONSE <sup>1, 4, 6</sup>	TRANSIENT	—	±250	±400	—	±250	±500	mV pk
	RECOVERY	—	200	300	—	200	300	μs
START-UP <sup>7</sup>	DELAY	—	3.5	6	—	3.5	6	ms
	OVERSHOOT <sup>1</sup>	—	—	50	—	—	50	mV pk
CAPACITIVE LOAD <sup>1, 8</sup>	T <sub>C</sub> = 25°C	—	—	1000	—	—	1000	μF

#### Notes

1. Guaranteed by characterization test and/or analysis. Not a production test.
2. Converter will shut down above approximately 45V but will be undamaged and will restart when voltage drops into normal range.
3. "OO" product may be 2% lower.
4. Recovery time is measured from application of the transient to point at which V<sub>out</sub> is within 1% of final value.
5. Step load test is performed at 10 microseconds typical.
6. Step line test is performed at 100 microseconds ± 20 microseconds.
7. Tested on release from inhibit.
8. No affect on dc performance.



# SMFL Single and Dual DC-DC Converters

## 28 VOLT INPUT – 65 WATT

TABLE 8: ELECTRICAL CHARACTERISTICS: -55°C TO +125°C CASE, 28 VIN, 100% LOAD, FREE RUN, UNLESS OTHERWISE SPECIFIED.

DUAL OUTPUT MODELS		SMFL2805D			SMFL2812D			SMFL2815D			UNITS
PARAMETER	CONDITIONS	MIN	TYP	MAX	MIN	TYP	MAX	MIN	TYP	MAX	
OUTPUT VOLTAGE	+V <sub>OUT</sub>	4.85	5.00	5.15	11.64	12.00	12.36	14.55	15.00	15.45	V
	-V <sub>OUT</sub>	4.82	5.00	5.18	11.58	12.00	12.42	14.47	15.00	15.53	
OUTPUT CURRENT <sup>2</sup> V <sub>IN</sub> = 16 TO 40 V	EITHER OUTPUT	0	±5	7	0	±2.5	3.5	0	±2.17	3.03	A
	TOTAL	0	—	10	0	—	5	0	—	4.33	
OUTPUT POWER <sup>2</sup> V <sub>IN</sub> = 16 TO 40 V	EITHER OUTPUT	0	±25	35	0	±30	42	0	±32.5	45.5	W
	TOTAL	0	—	50	0	—	60	0	—	65	
OUTPUT RIPPLE 10 kHz - 2 MHz ± V <sub>OUT</sub>	T <sub>C</sub> = 25°C	—	—	50	—	—	80	—	—	100	mV p-p
	T <sub>C</sub> = -55°C TO +125°C	—	50	100	—	50	120	—	50	150	
LINE REGULATION V <sub>IN</sub> = 16 TO 40 V	+V <sub>OUT</sub>	—	0	50	—	0	50	—	0	50	mV
	-V <sub>OUT</sub>	—	25	100	—	25	100	—	25	100	
LOAD REGULATION NO LOAD TO FULL	+V <sub>OUT</sub>	—	0	50	—	0	50	—	0	50	mV
	-V <sub>OUT</sub>	—	25	100	—	50	120	—	50	150	
CROSS REGULATION T <sub>C</sub> = 25°C	SEE NOTE 3	—	—	400	—	—	480	—	—	600	mV
	SEE NOTE 4	—	—	300	—	—	480	—	—	600	
INPUT VOLTAGE	+V <sub>OUT</sub>	16	28	40	16	28	40	16	28	40	V
	TRANSIENT 50 ms <sup>1, 5</sup>	—	—	80	—	—	80	—	—	80	
INPUT CURRENT	NO LOAD	—	50	120	—	50	100	—	50	100	mA
	INHIBITED-INH1	—	9	14	—	9	14	—	9	14	
	INHIBITED-INH2	—	35	70	—	35	70	—	35	70	
INPUT RIPPLE CURRENT	10 kHz - 10 MHz	—	30	50	—	30	50	—	30	80	mA p-p
EFFICIENCY BALANCED LOAD	T <sub>C</sub> = 25°C	75	78	—	81	84	—	82	85	—	%
	T <sub>C</sub> = -55°C TO +125°C	73	—	—	79	—	—	80	—	—	
LOAD FAULT	POWER DISSIPATION	—	12.5	18	—	10	16	—	10	16	W
	RECOVERY <sup>1</sup>	—	1.5	4.0	—	1.5	4.0	—	1.5	4.0	ms
STEP LOAD RESPONSE <sup>6, 7</sup> 50% - 100% - 50% ± V <sub>OUT</sub>	TRANSIENT	—	±250	±350	—	±450	±600	—	±500	±600	mV pk
	RECOVERY <sup>1</sup>	—	1.5	3.0	3.0	1.5	3.0	—	1.5	3.0	ms
STEP LINE RESPONSE <sup>1, 6, 8</sup> 16 - 40 - 16 V ± V <sub>OUT</sub>	TRANSIENT	—	±250	±300	—	±250	±400	—	±250	±500	mV pk
	RECOVERY	—	200	300	—	200	300	—	200	300	μs
START-UP <sup>9</sup>	DELAY	—	3.5	6	—	3.5	6	—	3.5	6	ms
	OVERSHOOT <sup>1</sup>	—	—	25	—	—	50	—	—	50	mV pk
CAPACITIVE LOAD <sup>1, 10, 11</sup>	T <sub>C</sub> = 25°C	—	—	500	—	—	500	—	—	500	μF

## Notes

1. Guaranteed by characterization test and/or analysis. Not a production test.
2. Up to 70% of the total output power/current is available from either output providing the opposite output is simultaneously carrying 30% of the total power/current.
3. Effect on negative V<sub>out</sub> from 50%/50% loads to 70%/30% or 30%/70% loads.
4. Effect on negative V<sub>out</sub> from 50%/50% loads to 50% then 10% load on negative V<sub>out</sub>.

5. Converter will shut down above approximately 45 volts but will be undamaged and will restart when voltage drops into normal range.

6. Recovery time is measured from application of the transient to point at which V<sub>out</sub> is within 1% of final value.

7. Step load test is performed at 10 microseconds typical.

8. Step line test is performed at 100 microseconds ± 20 microseconds.

9. Tested on release from inhibit.

10. No affect on dc performance.

11. Applies to each output.

# SMFL Single and Dual DC-DC Converters

## 28 VOLT INPUT – 65 WATT

TYPICAL PERFORMANCE PLOTS: 25°C CASE, 28 VIN, 100% LOAD, FREE RUN, UNLESS OTHERWISE SPECIFIED.  
 These are examples for reference only and are not guaranteed specifications.

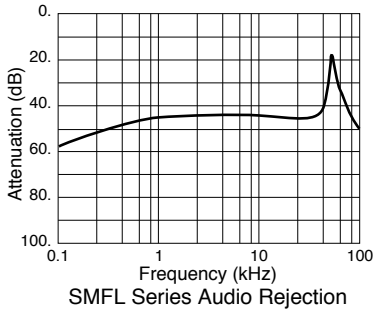

FIGURE 5

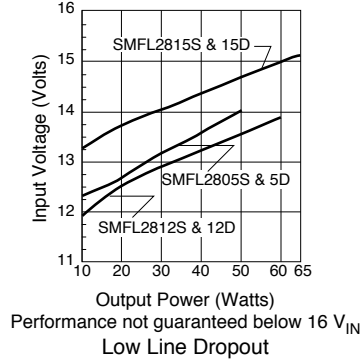

FIGURE 6

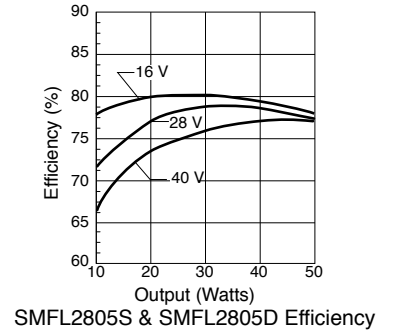

FIGURE 7

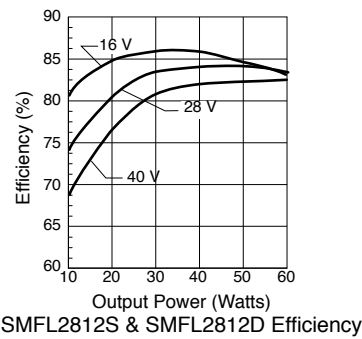

FIGURE 8

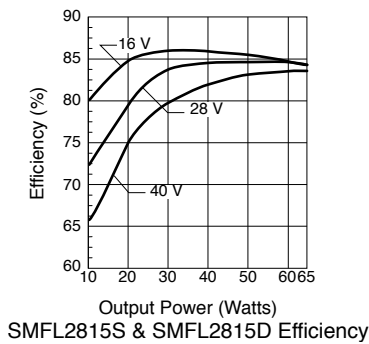

FIGURE 9

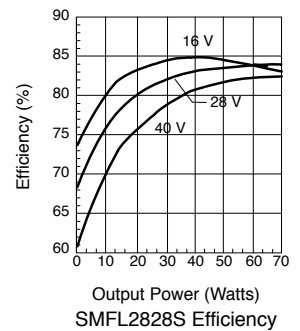

FIGURE 10

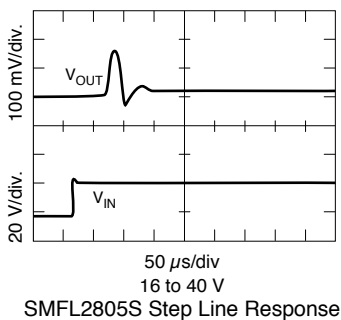

FIGURE 11

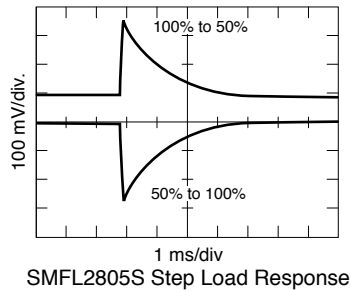

FIGURE 12

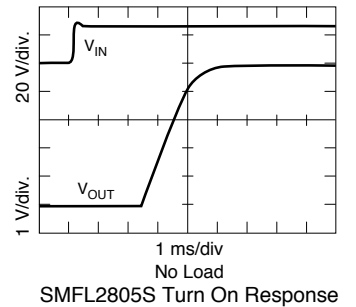

FIGURE 13

# SMFL Single and Dual DC-DC Converters

## 28 VOLT INPUT – 65 WATT

TYPICAL PERFORMANCE PLOTS: 25°C CASE, 28 VIN, 100% LOAD, FREE RUN, UNLESS OTHERWISE SPECIFIED.  
 These are examples for reference only and are not guaranteed specifications.

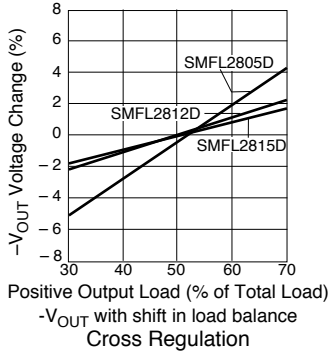

FIGURE 14

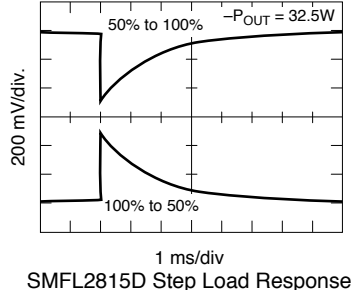

FIGURE 15

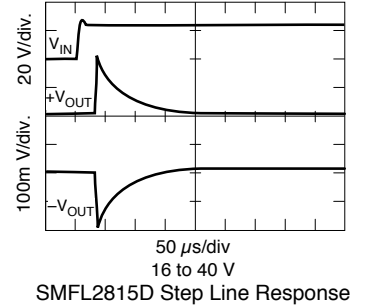

FIGURE 16

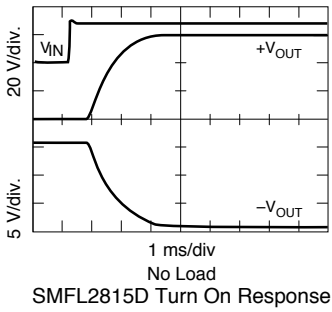

FIGURE 17

# SMFL Single and Dual DC-DC Converters

## 28 VOLT INPUT – 65 WATT

### TOP VIEW CASE U Flanged case, short leads

Case "U" does not require a designator in the Case Option position of the model number.

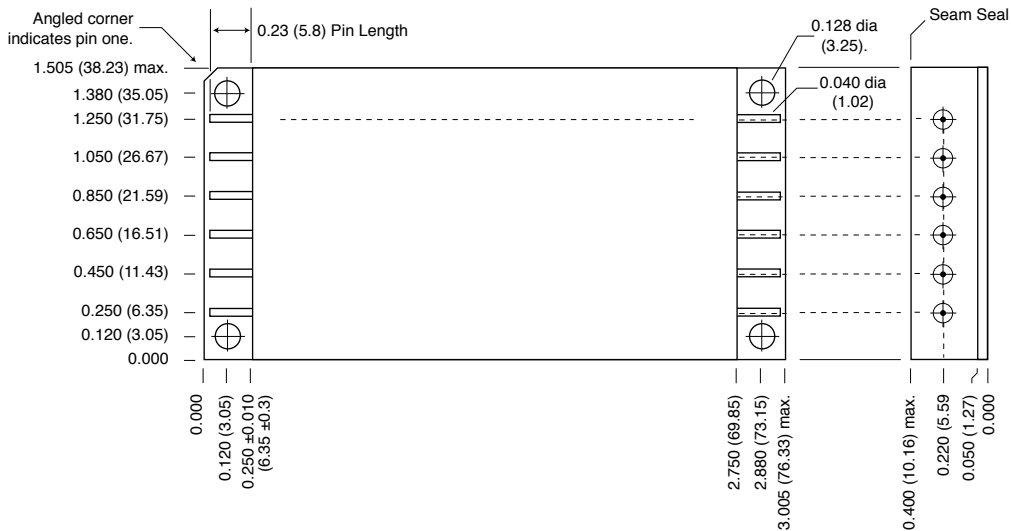

**Weight:** 86 grams maximum

**Case dimensions in inches (mm)**  
 Tolerance  $\pm 0.005$  (0.13) for three decimal places  
 $\pm 0.01$  (0.3) for two decimal places  
 unless otherwise specified

**CAUTION**  
 Heat from reflow or wave soldering may damage the device. Solder pins individually with heat application not exceeding 300°C for 10 seconds per pin.

**Materials**  
 Header Cold Rolled Steel/Nickel/Gold  
 Cover Kovar/Nickel  
 Pins #52 alloy/Gold ceramic seal  
 Gold plating of 50 - 150 microinches is included in pin diameter  
 Seal Hole: 0.120  $\pm 0.002$  (3.05  $\pm 0.05$ )

Please refer to the numerical dimensions for accuracy.

FIGURE 18: CASE U

# SMFL Single and Dual DC-DC Converters

## 28 VOLT INPUT – 65 WATT

### ELEMENT EVALUATION SPACE DC-DC CONVERTERS PROTOTYPE, CLASS H AND CLASS K

COMPONENT-LEVEL TEST PERFORMED	NON-QML <sup>1</sup>	QML			
	PROTOTYPE	CLASS H		CLASS K	
	/O	/H		/K	
	M/S <sup>2</sup>	M/S <sup>2</sup>	P <sup>3</sup>	M/S <sup>2</sup>	P <sup>3</sup>
Element Electrical	■	■	■	■	■
Visual		■	■	■	■
Internal Visual		■		■	
Temperature Cycling				■	■
Constant Acceleration				■	■
Interim Electrical				■	
Burn-in				■	
Post Burn-in Electrical				■	
Steady State Life				■	
Voltage Conditioning Aging					■
Visual Inspection					■
Final Electrical		■	■	■	■
Wire Bond Evaluation		■	■	■	■
SEM				■	
C-SAM: Input capacitors only <sup>4</sup>			■		■

#### Notes

1. Non-QML products may not meet all of the requirements of MIL-PRF-38534.
2. M/S = Active components (microcircuit and semiconductor die)
3. P = Passive components, Class H and K element evaluation. Not applicable to space prototype ("O") element evaluation.
4. Additional test not required by H or K.

#### Definitions

Element Evaluation: Component testing/screening per MIL-STD-883 as determined by MIL-PRF-38534  
SEM: scanning electron microscopy  
C-SAM: C – Mode Scanning Acoustic Microscopy

TABLE 9: ELEMENT EVALUATION

# SMFL Single and Dual DC-DC Converters

## 28 VOLT INPUT – 65 WATT

### ENVIRONMENTAL SCREENING SPACE DC-DC CONVERTERS PROTOTYPE, CLASS H AND CLASS K, RHA <sup>1</sup> P, L AND R

TEST PERFORMED	NON-QML <sup>2</sup>	QML <sup>3</sup>					
	PROTOTYPE	CLASS H			CLASS K		
	/OO <sup>4</sup>	/HP	/HL	/HR	/KP	/KL	/KR
Non-destruct wire bond pull, Method 2023		■ <sup>5</sup>	■ <sup>5</sup>	■ <sup>5</sup>	■	■	■
Pre-cap Inspection, Method 2017, 2032	■	■	■	■	■	■	■
Temperature Cycle (10 times) Method 1010, Cond. C, -65°C to +150°C, ambient	■	■	■	■	■	■	■
Constant Acceleration Method 2001, 3000 g	■	■	■	■	■	■	■
PIND, Test Method 2020, Cond. A		■ <sup>5</sup>	■ <sup>5</sup>	■ <sup>5</sup>	■	■	■
Pre burn-in test, Group A, Subgroups 1 and 4	■	■ <sup>5</sup>	■ <sup>5</sup>	■ <sup>5</sup>	■	■	■
Burn-in Method 1015, +125°C case, typical <sup>6</sup>							
96 hours	■						
160 hours		■	■	■			
2 x 160 hours (includes mid-BI test)					■	■	■
Final Electrical Test, MIL-PRF-38534, Group A,							
Subgroups 1 and 4: +25°C case	■						
Subgroups 1 through 6, -55°C, +25°C, +125°C case		■	■	■	■	■	■
Hermeticity Test, Method 1014							
Gross Leak, Cond. B <sub>2</sub> , Kr85					■	■	■
Gross Leak, Cond. C <sub>1</sub> , fluorocarbon	■	■	■	■			
Fine Leak, Cond. B <sub>1</sub> , Kr85					■	■	■
Fine Leak, Cond. A <sub>2</sub> , helium	■	■	■	■			
Radiography, Method 2012					■	■	■
Post Radiography Electrical Test, +25°C case					■ <sup>5</sup>	■ <sup>5</sup>	■ <sup>5</sup>
Final visual inspection, Method 2009	■	■	■	■	■	■	■
RHA P: 30 krad(Si) total dose <sup>1, 7, 8</sup>		■			■		
RHA L: 50 krad(Si) total dose <sup>1, 7, 8</sup>			■			■	
RHA R: 100 krad(Si) total dose <sup>1, 7, 8</sup>				■			■
SEE, LET 86 MeV cm <sup>2</sup> /mg <sup>1, 9</sup>		■	■	■	■	■	■

Test methods are referenced to MIL-STD-883 as determined by MIL-PRF-38534.

#### Notes

- Our Redmond facility has a DLA approved RHA plan for Interpoint power products. Our SMD products with RHA "P", "L" or "R" code meet DLA requirements.
- Non-QML prototype products may not meet all of the requirements of MIL-PRF-38534.
- All processes are QML qualified and performed by certified operators.
- "O" in the RHA designator position in Interpoint model numbers indicates DLA RHA "-" defined as no RHA.

- Not required by DLA but performed to assure product quality.
- Burn-in temperature designed to bring the case temperature to +125°C minimum. Burn-in is a powered test.
- High dose rate test.
- Low dose rate test.
- No destructive events or SEL.

TABLE 10: ENVIRONMENTAL SCREENING AND RHA LEVELS